

Maintenance Switches for  
**EMC-compliant Connection**

Maintenance Switches for  
**EMC-compliant connection**

Maintenance Switches and Safety Switches  
 according to IEC 60204 and VDE 0113  
 for EMC-compliant connection of  
 frequency regulated motors

## CONTENT

Please choose the suitable Maintenance Switch due to the power data of your projected drive from the table below.

< Click the page number to get there. >

Nominal Rating:		3 pole Page	6 pole Page
Thermal Current $I_{the}$	Motor Rating AC-23B/A, 3x400V		
20 A	5,5 kW	3	-
25 A	7,5 kW	4	10
32 A	11 kW	4	10
40 A	15 kW	5	11
63 A	22 kW	5	11
80 A	30 kW	6	12
100 A	37 kW	6	12
125 A	45 kW	7	13
160 A	55 kW	7	13
200 A	75 kW	-	14
250 A	90 kW	8	-
275 A	132 kW	-	14
315 A	110 kW	8	-
315 A	132 kW	9	-
UPGRADE KIT		15	
<b>Sales Contact</b>		16	

### Note:

Maintenance Switches for EMC-compliant connection of FU-regulated drives are available either with shield clips (KS- and KL-enclosure) or with clips mounted on DIN-rails (STM-enclosure). These clips are used to continue the cable shield circuit through the enclosure.

The configuration of the Maintenance Switch between FU and motor allows the use as Disconnector up to 400 Hz and as Load Switch at frequencies from 40 Hz to 100 Hz.

Each Maintenance Switch has as standard 2 auxiliary contacts, 1 NC and 1 NO. Via the NO (20 ms leading) the FU can be switched off before the main contacts of the switch open.

For the rating of the switch please note that the motor may have approx. 10 % higher charging rate due to the higher loss in FU-operation e.g. a motor with 7,5 kW rating the motor current has to be determined with 16,7 A instead of 15,2 A.

20 A / 5,5 kW → KG10

Maintenance Switches for  
**EMC-compliant connection**

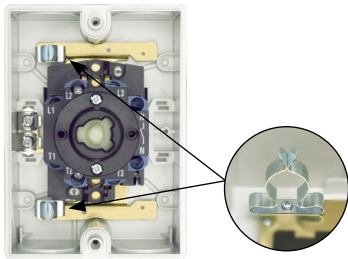
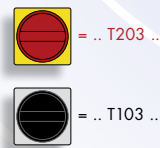
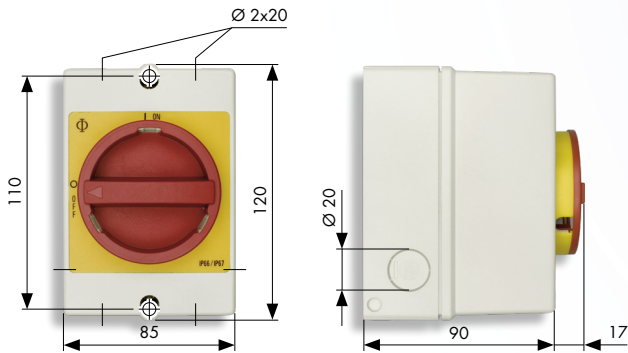

Connection diagram	Recommended tightening torque for terminal screws	
<pre> PE  L1  L2  L3  13  21    /  /  /  /  / PE  T1  T2  T3  14  22                     </pre>	KG10	0,8 Nm
External-Ø shield	Insulation stripping length	
9 – 11		

**Contact development: 3 pole with auxiliary contacts 1NC/1NO** (leading off)

**General Data**

Switch Disconnectors according to EN 60947-3 and VDE 0660 part 107  
Ambient temperature (enclosed): 35 °C during 24 hours with peaks up to 40 °C

**Equipment**

Plastic enclosure, protection IP 66/67, knock-outs  
Handle in the OFF-position lockable with padlocks, special safety interlocked covers with enclosure  
With shield clips for use to continue the cable shield circuit through the enclosure

**Rated Data / Order Number**

Thermal Current $I_{the}$	Utilization Category AC-23 B/A, 3x400 V	Breaking Capacity 3x400 V	Color Handle / Backing	Order Number
20 A	5,5 kW	120 A		KG10 T203/D-A076 KS51V
				KG10 T103/D-A050 KS51V

∨ Back to the table of contents ∨

**25 A / 7,5 kW** ➔ **KG20**  
**32 A / 11 kW** ➔ **KG32**

Maintenance Switches for  
**EMC-compliant connection**

Maintenance Switches and Safety Switches according to IEC 60204 and VDE 0113 for EMC-compliant connection of frequency regulated motors

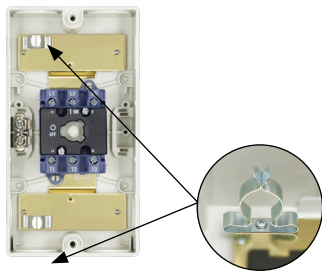
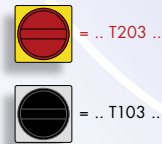
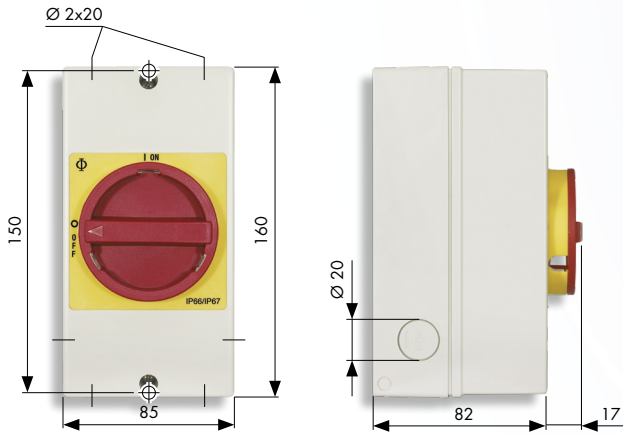

Connection diagram		Recommended tightening torque for terminal screws	
PE	L1 L2 L3 13 21	KG20 KG32	1,25 Nm 1,25 Nm
PE	T1 T2 T3 14 22		
External-Ø shield		Insulation stripping length	
12 – 16			

**Contact development: 3 pole with auxiliary contacts 1NC/1NO** (leading off)

**General Data**

Switch Disconnectors according to EN 60947-3 and VDE 0660 part 107  
 Ambient temperature (enclosed): 35 °C during 24 hours with peaks up to 40 °C

**Equipment**

Plastic enclosure, protection IP 66/67, knock-outs  
 Handle in the OFF-position lockable with padlocks, special safety interlocked covers with enclosure  
 With shield clips for use to continue the cable shield circuit through the enclosure

**Rated Data / Order Number**

Thermal Current $I_{the}$	Utilization Category AC-23 B/A, 3x400 V	Breaking Capacity 3x400 V	Color Handle / Backing	Order Number
25 A	7,5 kW	180 A		KG20 T203/D-A159 KL51V
				KG20 T103/D-A126 KL51V
32 A	11 kW	220 A		KG32 T203/D-A117 KL51V
				KG32 T103/D-A061 KL51V

Back to the table of contents >

40 A / 15 kW ➔ KG41  
 63 A / 22 kW ➔ KG64

Maintenance Switches for  
**EMC-compliant connection**

Maintenance Switches and Safety Switches according to IEC 60204 and VDE 0113 for EMC-compliant connection of frequency regulated motors

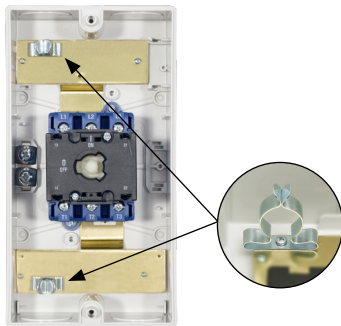
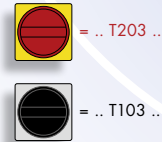
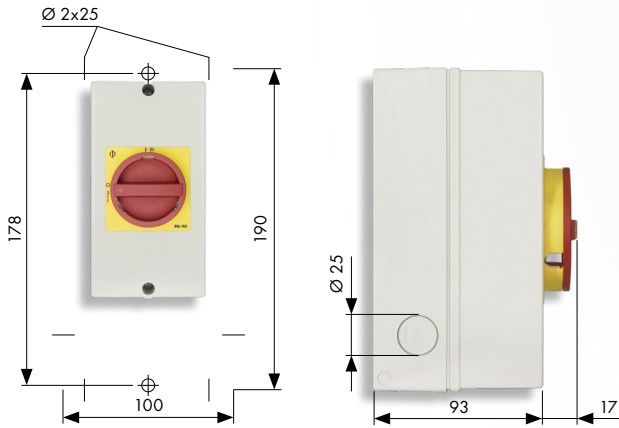

Connection diagram		Recommended tightening torque for terminal screws	
PE	L1 L2 L3 13 21	KG41	1,80 Nm
		KG64	1,80 Nm
PE	T1 T2 T3 14 22		
External-Ø shield		Insulation stripping length	
12 – 16			

**Contact development: 3 pole with auxiliary contacts 1NC/1NO** (leading off)

**General Data**

Switch Disconnectors according to EN 60947-3 and VDE 0660 part 107  
 Ambient temperature (enclosed): 35 °C during 24 hours with peaks up to 40 °C

**Equipment**

Plastic enclosure, protection IP 66/67, knock-outs  
 Handle in the OFF-position lockable with padlocks, special safety interlocked covers with enclosure  
 With shield clips for use to continue the cable shield circuit through the enclosure

**Rated Data / Order Number**

Thermal Current $I_{the}$	Utilization Category AC-23 B/A, 3x400 V	Breaking Capacity 3x400 V	Color Handle / Backing	Order Number
40 A	15 kW	300 A		KG41 T203/D-A145 KL11V
				KG41 T103/D-A087 KL11V
63 A	22 kW	350 A		KG64 T203/D-A173 KL11V
				KG64 T103/D-A103 KL11V

Back to the table of contents >

**80 A / 30 kW** ➔ *KG80*  
**100 A / 37 kW** ➔ *KG100*

Maintenance Switches for  
**EMC-compliant connection**

Maintenance Switches and Safety Switches according to IEC 60204 and VDE 0113 for EMC-compliant connection of frequency regulated motors

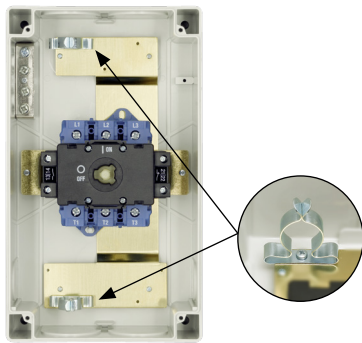
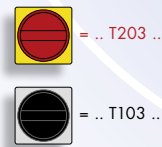
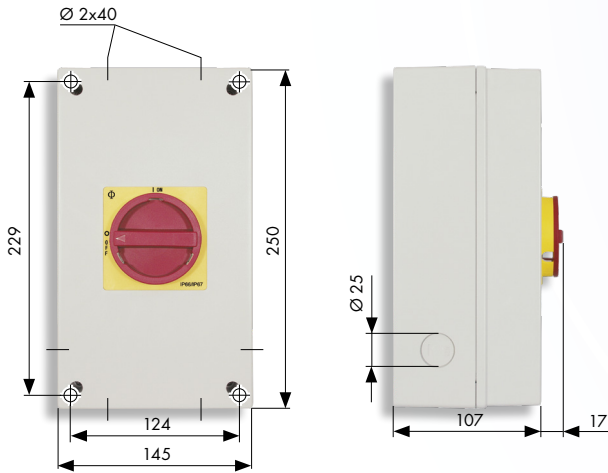

Connection diagram		Recommended tightening torque for terminal screws	
PE	L1 L2 L3 13 21	KG80	3,00 Nm
		KG100	3,00 Nm
PE	T1 T2 T3 14 22		
External-Ø shield		Insulation stripping length	
23 – 29			

**Contact development: 3 pole with auxiliary contacts 1NC/1NO** (leading off)

**General Data**

Switch Disconnectors according to EN 60947-3 and VDE 0660 part 107  
 Ambient temperature (enclosed): 35 °C during 24 hours with peaks up to 40 °C

**Equipment**

Plastic enclosure, protection IP 66/67, knock-outs  
 Handle in the OFF-position lockable with padlocks, special safety interlocked covers with enclosure  
 With shield clips for use to continue the cable shield circuit through the enclosure

**Rated Data / Order Number**

Thermal Current $I_{the}$	Utilization Category AC-23 B/A, 3x400 V	Breaking Capacity 3x400 V	Color Handle / Backing	Order Number
80 A	30 kW	560 A		<i>KG80 T203/D-A108 KL71V</i>
				<i>KG80 T103/D-A061 KL71V</i>
100 A	37 kW	650 A		<i>KG100 T203/D-A120 KL71V</i>
				<i>KG100 T103/D-A068 KL71V</i>

▼ Back to the table of contents ^

125 A / 45 kW ➔ KG125  
 160 A / 55 kW ➔ KG160

Maintenance Switches for  
**EMC-compliant connection**

Maintenance Switches and Safety Switches according to IEC 60204 and VDE 0113 for EMC-compliant connection of frequency regulated motors

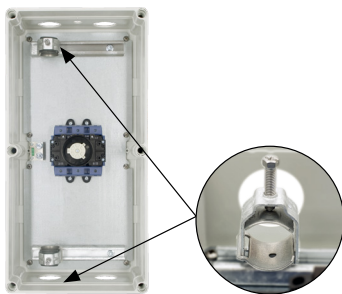
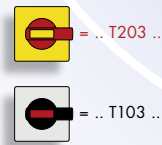
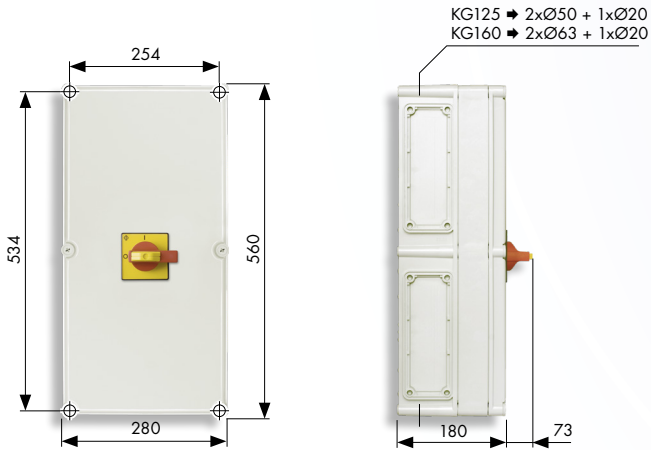

Connection diagram	Recommended tightening torque for terminal screws	
	KG125	14 Nm
	KG160	14 Nm
External-Ø shield	Insulation stripping length	
34 – 40		

**Contact development: 3 pole with auxiliary contacts 1NC/1NO** (leading off)

**General Data**

Switch Disconnectors according to EN 60947-3 and VDE 0660 part 107  
 Ambient temperature (enclosed): 35 °C during 24 hours with peaks up to 40 °C

**Equipment**

Plastic enclosure, protection IP 66/67, Handle in the OFF-position lockable with padlocks, special safety interlocked covers with enclosure with on DIN-rails mounted clips for use to continue the cable shield circuit through the enclosure

**Rated Data / Order Number**

Thermal Current $I_{the}$	Utilization Category AC-23 B/A, 3x400 V	Breaking Capacity 3x400 V	Color Handle / Backing	Order Number
125 A	45 kW	750 A		KG125 T203/D-A082 STM
				KG125 T103/D-A070 STM
160 A	55 kW	850 A		KG160 T203/D-A077 STM
				KG160 T103/D-A066 STM

Back to the table of contents

**250 A / 90 kW** → *KG250*  
**315 A / 110 kW** → *KG315*

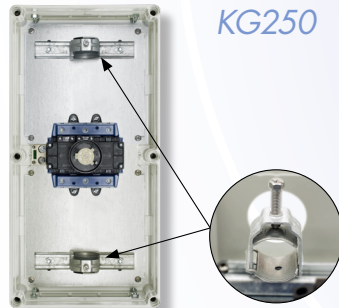
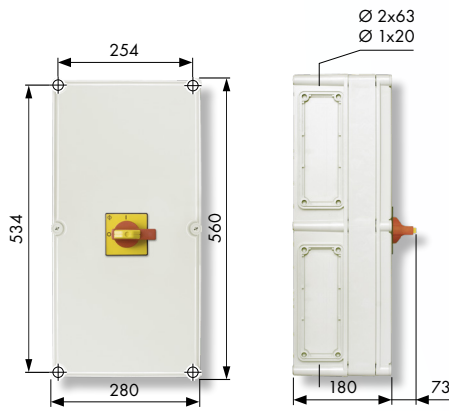

*KG250*

Maintenance Switches for  
**EMC-compliant connection**

Maintenance Switches and Safety Switches according to IEC 60204 and VDE 0113 for EMC-compliant connection of frequency regulated motors

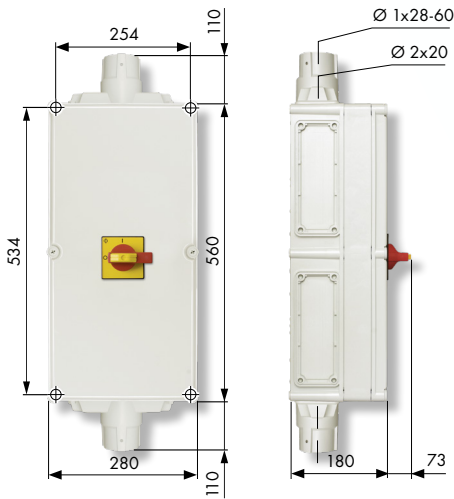
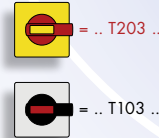

*KG315*

Connection diagram		Recommended tightening torque for terminal screws	
PE	L1 L2 L3 13 21	KG250 KG315	16 Nm 16 Nm
PE	T1 T2 T3 14 22		
External-Ø shield		Insulation stripping length	
KG250	34 – 40		
KG315	46 – 52		

Back to the table of contents >

**Contact development: 3 pole with auxiliary contacts 1NC/1NO (leading off)**

**General Data**

Switch Disconnectors according to EN 60947-3 and VDE 0660 part 107  
 Ambient temperature (enclosed): 35 °C during 24 hours with peaks up to 40 °C

**Equipment**

Plastic enclosure, protection IP 66/67, Handle in the OFF-position lockable with padlocks, special safety interlocked covers with enclosure with on DIN-rails mounted clips for use to continue the cable shield circuit through the enclosure

**Rated Data / Order Number**

Thermal Current $I_{the}$	Utilization Category AC-23 B/A, 3x400 V	Breaking Capacity 3x400 V	Color Handle / Backing	Order Number
250 A	90 kW	1380 A		<i>KG250 T203/D-A075 STM</i>
				<i>KG250 T103/D-A073 STM</i>
315 A	110 kW	1650 A		<i>KG315 T203/D-A034 STM</i>
				<i>KG315 T103/DA043 STM</i>



**315 A / 132 kW** → C316

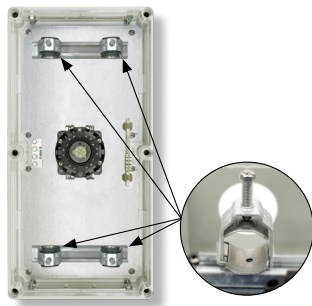
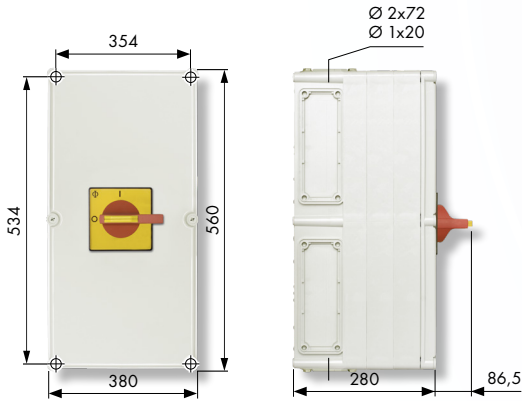

Maintenance Switches for  
**EMC-compliant connection**

Maintenance Switches and Safety Switches according to IEC 60204 and VDE 0113 for EMC-compliant connection of frequency regulated motors

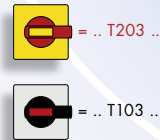

Connection diagram		Recommended tightening torque for terminal screws	
<pre> PE  L1  L2  L3  103  101                                     PE  T1  T2  T3  104  102                     </pre>	C316	14 Nm	
External-Ø shield		Connecting bolts	
C316	46 – 52	M12	

**Contact development: 3 pole with auxiliary contacts 1NC/1NO** (leading off)

**General Data**

Switch Disconnectors according to EN 60947-3 and VDE 0660 part 107  
Ambient temperature (enclosed): 35 °C during 24 hours with peaks up to 40 °C

**Equipment**

Plastic enclosure, protection IP 66/67, Handle in the OFF-position lockable with padlocks, special safety interlocked covers with enclosure with on DIN-rails mounted clips for use to continue the cable shield circuit through the enclosure

**Rated Data / Order Number**

Thermal Current $I_{the}$	Utilization Category AC-23 B/A, 3x400 V	Breaking Capacity 3x400 V	Color Handle / Backing	Order Number
315 A	132 kW	2000 A		C316 T203/D-A037 STM
				C316 T103/D-A025 STM

∨ Back to the table of contents ^

**25 A / 7,5 kW** ➔ **KG20B**  
**32 A / 11 kW** ➔ **KG32B**

Maintenance Switches for  
**EMC-compliant connection**

Maintenance Switches and Safety Switches according to IEC 60204 and VDE 0113 for EMC-compliant connection of frequency regulated motors

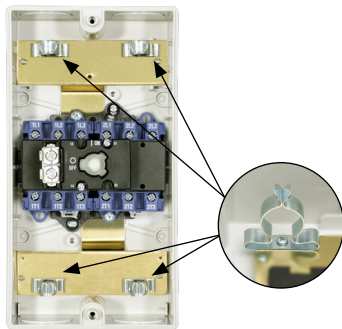
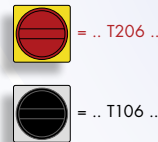
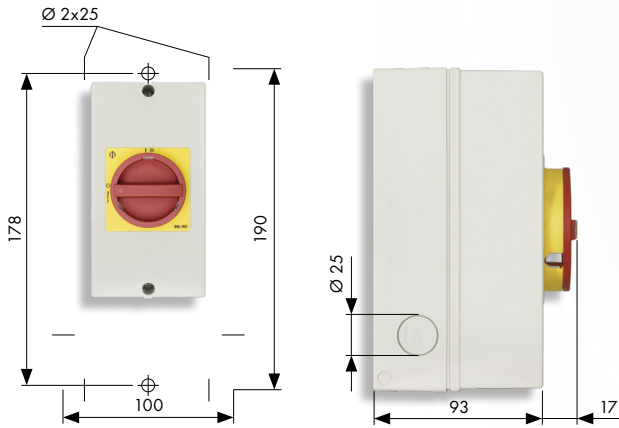

Connection diagram		Recommended tightening torque for terminal screws	
PE	1L1 1L2 1L3 2L1 2L2 2L3 13 21	KG20B	1,25 Nm
PE	1T1 1T2 1T3 2T1 2T2 2T3 14 22	KG32B	1,25 Nm
External-Ø shield		Insulation stripping length	
12 – 16			

**Contact development: 6 pole with auxiliary contacts 1NC/1NO** (leading off)

**General Data**

Switch Disconnectors according to EN 60947-3 and VDE 0660 part 107  
 Ambient temperature (enclosed): 35 °C during 24 hours with peaks up to 40 °C

**Equipment**

Plastic enclosure, protection IP 66/67, knock-outs  
 Handle in the OFF-position lockable with padlocks, special safety interlocked covers with enclosure  
 With shield clips for use to continue the cable shield circuit through the enclosure

**Rated Data / Order Number**

Thermal Current $I_{the}$	Utilization Category AC-23 B/A, 3x400 V	Breaking Capacity 3x400 V	Color Handle / Backing	Order Number
25 A	7,5 kW	180 A		KG20B T206/D-A059 KL11V
				KG20B T106/D-A046 KL11V
32 A	11 kW	220 A		KG32B T206/D-A054 KL11V
				KG32B T106/D-A040 KL11V

▼ Back to the table of contents ▲

**40 A / 15 kW** ➔ *KG41B*  
**63 A / 22 kW** ➔ *KG64B*

Maintenance Switches for  
**EMC-compliant connection**

Maintenance Switches and Safety Switches according to IEC 60204 and VDE 0113 for EMC-compliant connection of frequency regulated motors

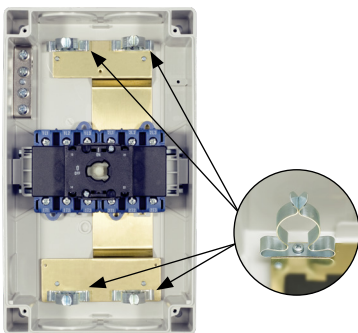
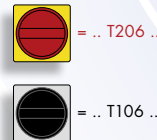
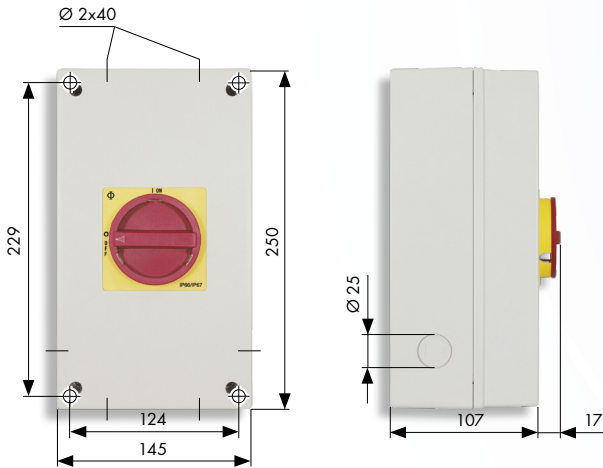

Connection diagram		Recommended tightening torque for terminal screws	
	KG41B KG64B	1,80 Nm 1,80 Nm	
External-Ø shield		Insulation stripping length	
23 – 29			

**Contact development: 6 pole with auxiliary contacts 1NC/1NO** (leading off)

**General Data**

Switch Disconnectors according to EN 60947-3 and VDE 0660 part 107  
 Ambient temperature (enclosed): 35 °C during 24 hours with peaks up to 40 °C

**Equipment**

Plastic enclosure, protection IP 66/67, knock-outs  
 Handle in the OFF-position lockable with padlocks, special safety interlocked covers with enclosure  
 With shield clips for use to continue the cable shield circuit through the enclosure

**Rated Data / Order Number**

Thermal Current $I_{the}$	Utilization Category AC-23 B/A, 3x400 V	Breaking Capacity 3x400 V	Color Handle / Backing	Order Number
40 A	15 kW	300 A		<i>KG41B T206/D-A052 KL71V</i>
				<i>KG41B T106/D-A032 KL71V</i>
63 A	22 kW	350 A		<i>KG64B T206/D-A066 KL71V</i>
				<i>KG64B T106/D-A038 KL71V</i>

▼ Back to the table of contents ▲

80 A / 30 kW → KG80C  
 100 A / 37 kW → KG100C

Maintenance Switches for  
**EMC-compliant connection**

Maintenance Switches and Safety Switches according to IEC 60204 and VDE 0113 for EMC-compliant connection of frequency regulated motors

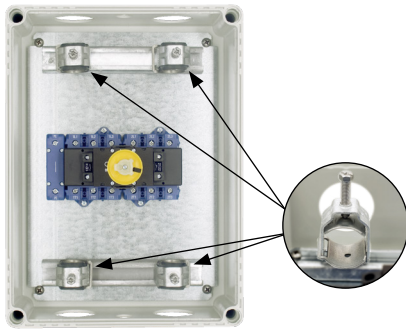
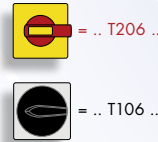
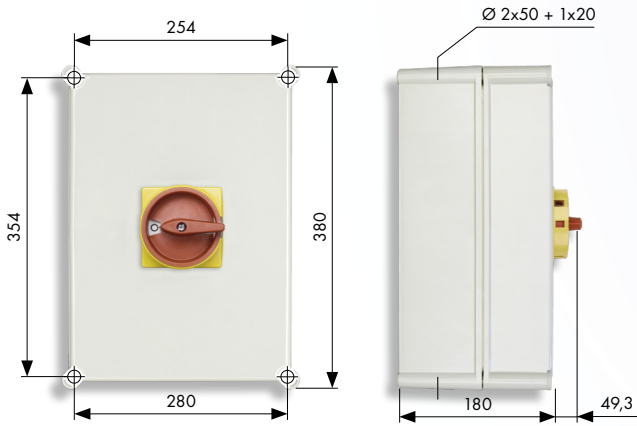

Connection diagram	Recommended tightening torque for terminal screws	
	KG80C	3 Nm
	KG100C	3 Nm
External-Ø shield	Insulation stripping length	
28 – 34		

**Contact development: 6 pole with auxiliary contacts 1NC/1NO** (leading off)

**General Data**

Switch Disconnectors according to EN 60947-3 and VDE 0660 part 107  
 Ambient temperature (enclosed): 35 °C during 24 hours with peaks up to 40 °C

**Equipment**

Plastic enclosure, protection IP 66/67, Handle in the OFF-position lockable with padlocks, special safety interlocked covers with enclosure with on DIN-rails mounted clips for use to continue the cable shield circuit through the enclosure

**Rated Data / Order Number**

Thermal Current $I_{the}$	Utilization Category AC-23 B/A, 3x400 V	Breaking Capacity 3x400 V	Color Handle / Backing	Order Number
80 A	30 kW	560 A		KG80C T206/D-A070 STM
				KG80C T106/D-A055 STM
100 A	37 kW	650 A		KG100C T206/D-A060 STM
				KG100C T106/D-A049 STM

∨ Back to the table of contents ^

**125 A / 45 kW** ➔ *KG125*  
**160 A / 55 kW** ➔ *KG160*

Maintenance Switches for  
**EMC-compliant connection**

Maintenance Switches and Safety Switches according to IEC 60204 and VDE 0113 for EMC-compliant connection of frequency regulated motors

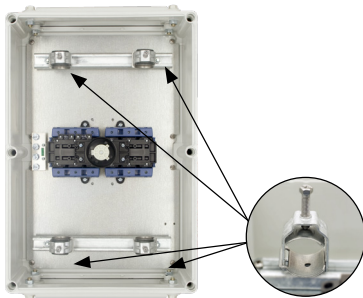
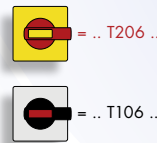
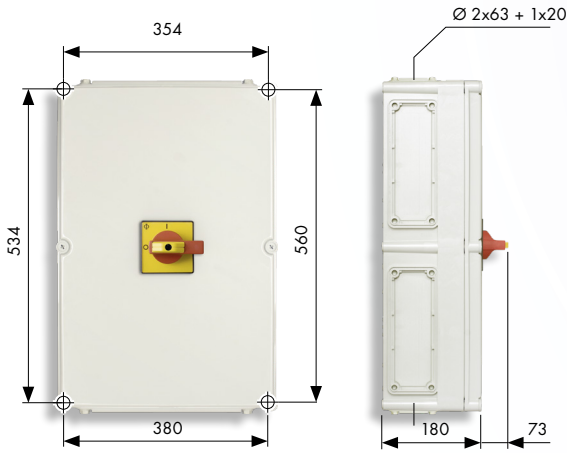

Connection diagram	Recommended tightening torque for terminal screws	
	KG125	14 Nm
	KG160	14 Nm
External-Ø shield	Insulation stripping length	
34 – 40		

▼ Back to the table of contents ▲

**Contact development: 6 pole with auxiliary contacts 1NC/1NO** (leading off)

**General Data**

Switch Disconnectors according to EN 60947-3 and VDE 0660 part 107  
 Ambient temperature (enclosed): 35 °C during 24 hours with peaks up to 40 °C

**Equipment**

Plastic enclosure, protection IP 66/67, Handle in the OFF-position lockable with padlocks, special safety interlocked covers with enclosure with on DIN-rails mounted clips for use to continue the cable shield circuit through the enclosure

**Rated Data / Order Number**

Thermal Current $I_{the}$	Utilization Category AC-23 B/A, 3x400 V	Breaking Capacity 3x400 V	Color Handle / Backing	Order Number
125 A	45 kW	750 A		<i>KG125 T206/D-A020 STM</i>
				<i>KG125 T106/D-A031 STM</i>
160 A	55 kW	850 A		<i>KG160 T206/D-A040 STM</i>
				<i>KG160 T106/D-A024 STM</i>

**200 A / 75 kW** ➔ C200-4  
**275 A / 132 kW** ➔ C316

Maintenance Switches for  
**EMC-compliant connection**

Maintenance Switches and Safety Switches according to IEC 60204 and VDE 0113 for EMC-compliant connection of frequency regulated motors

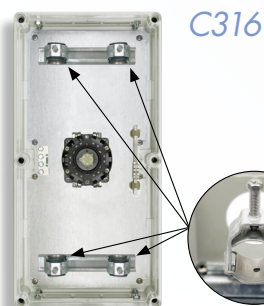
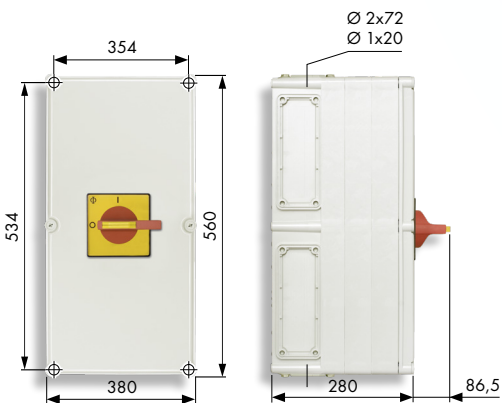
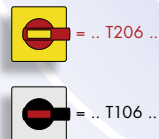
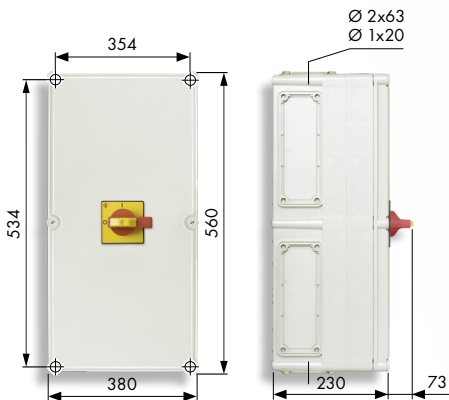

Connection diagram		Recommended tightening torque for terminal screws	
		C200-4 C316	8 Nm 14 Nm
External-Ø shield		Connecting bolts	
C200-4 C316	34 – 40 46 – 52	C200-4 C316	M8 M12

**Contact development: 6 pole with auxiliary contacts 1NC/1NO** (leading off)

**General Data**

Switch Disconnectors according to EN 60947-3 and VDE 0660 part 107  
 Ambient temperature (enclosed): 35 °C during 24 hours with peaks up to 40 °C

**Equipment**

Plastic enclosure, protection IP 66/67, Handle in the OFF-position lockable with padlocks, special safety interlocked covers with enclosure with on DIN-rails mounted clips for use to continue the cable shield circuit through the enclosure

**Rated Data / Order Number**

Thermal Current $I_{the}$	Utilization Category AC-23 B/A, 3x400 V	Breaking Capacity 3x400 V	Color Handle / Backing	Order Number
200 A	75 kW	1300 A		C200-4 T206/D-A001 STM
				C200-4 T106/D-A001 STM
275 A	132 kW	2000 A		C316 T206/D-A050 STM
				C316 T106/D-A033 STM

Back to the table of contents ^

# UPGRADE KIT

Maintenance Switches for  
**EMC-compliant connection**

## Shield wheeling kits

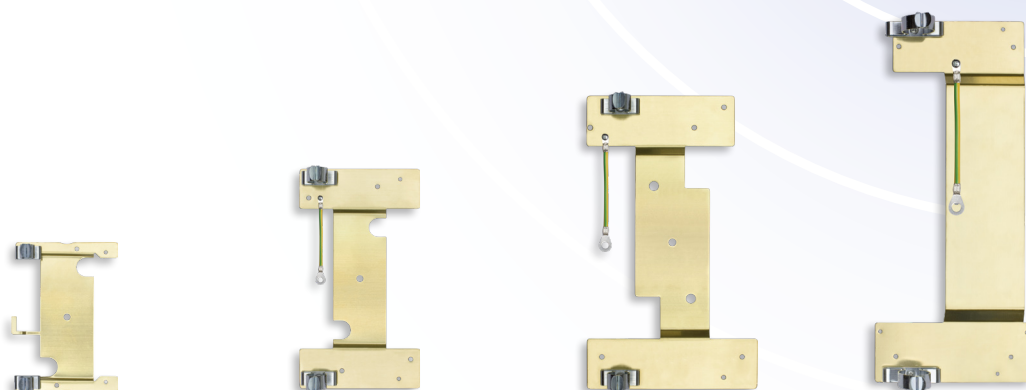

### Standard KS- KL-Enclosure

Dimensions enclosure	85 x 120	85 x 160	100 x 190	145 x 250
External-Ø shield	9 – 11	12 – 16	12 – 16	23 – 29
Order Number	<a href="#">SOE T400 MA</a>	<a href="#">KOB T400 MA</a>	<a href="#">K1B T400 MA</a>	<a href="#">K2B T400 MA</a>

Shielding clamp suitable for double side connecting. Scope of delivery: panel sheet, 2 shielding clamps, mounting screws

Shield wheeling kit available for 3 pole switches up to KG100.... And 6 pole switches up to KG64. All relevant catalogue listed repair switches can be upgraded with shield wheeling kits. The switch body has to be demounted first before mounting the shield wheeling.

## Shielding clamp (separate)



External-Ø shield	9 – 11	12 – 16	23 – 29
Order Number	<a href="#">K1B T400 KB</a>	<a href="#">K1B T400 KC</a>	<a href="#">K1B T400 KE</a>

Back to the table of contents >



 Kraus & Naimer

[www.krausnaimer.com](http://www.krausnaimer.com)

Follow us on



© Kraus & Naimer 2020