

Switch and Optional Extras

KG type up to 315 A

KH and KHR type up to 80 A



Kraus & Naimer

The development of the Blue Line rotary switch and motor starter product ranges is based on more than hundred years experience by Kraus & Naimer in the design and manufacture of electrical switchgear. Kraus & Naimer pioneered the introduction of the cam operated rotary switch and continues to be recognized as the world leader in that product field.

BLUE LINE

Blue Line products are protected by numerous patents through-out the industrial world. They are built to national and international standards and designed to withstand adverse temperatures and climates.

Blue Line products are accepted and universally recognized for their quality and workmanship. They are supported by a worldwide sales and service organization.

The Kraus & Naimer Registered Trademark

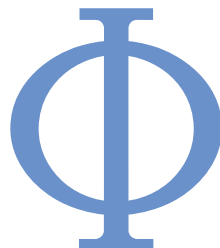

WORLDWIDE SYMBOL
FOR QUALITY SWITCHGEAR

Disconnectors and Main Switches acc. to IEC 60947-3 see Catalog 500

Contents	KG Switches	KH, KHR Switches
	Page	Page
Construction Data	4	25
Nominal Ratings	5	25
How to order	6, 7	6, 7
Types of Mounting and Enclosures	8-10	26, 27
Switch Function and Configuration	11-13	27
Face plates	14	28
Handles	15	29
Optional Extras		
Shaft Extensions	18	31
Auxiliary Contacts	16	30, 31
Protective Covers	16	30
Ground and Neutral Terminals	17	31
Padlock Devices	20	34
Door Clutches	18, 19	32, 33
Additional Main Contacts	17	
Additional Module for Motor Control Center (MCC)	21	
Angular drive	21	
Technical Data	22, 23	36, 37
Tightening torque of screws	23	37
International Standards and Approvals	24	35
Dimensions		
Types of Mounting and Enclosures	38-42	48, 49, 51
Optional Extras	42-47	50-53
Blue Line Switchgear: Summary		54

Disconnectors and Main Switches according to IEC 60947-3 see Catalog 500

The KG10A through KG317 switch line offers excellent performance characteristics and exceed the requirements of IEC 60947-3 as well as the new VDE 0660 part 107. KG switches are principally used as motor and industrial panel disconnectors, double-throw transfer switches, safety switches, main disconnect switches and distribution system isolation switches. This durable switch line possesses high short-circuit withstand capabilities, with positive contact movement during making and breaking functions. KG switches exhibit excellent AC-3 and AC-23 making and breaking capabilities providing an additional safety advantage.

The safety level of the KG switch series in numerous areas surpasses those of many international standards organizations: Positive contact movement during making and breaking operations. Higher dimensioned air and creepage distances for 690 V or 1000 V. Dead front, finger-proof box terminals according to EN 50274, VDE 0660 part 514 and DGUV V3. Switch types KG210, KG250 and KG315 require an option protective cover.

This advanced switch-generation affords significant advantages during mounting and wiring. For ease of installation, switch terminals are on the same plane as the power conductors. The KG10A through KG105C base mounted switches feature a two hole mounting as well as a "quick mount" designed for standard DIN rails according to EN 50022. KG125 through KG317





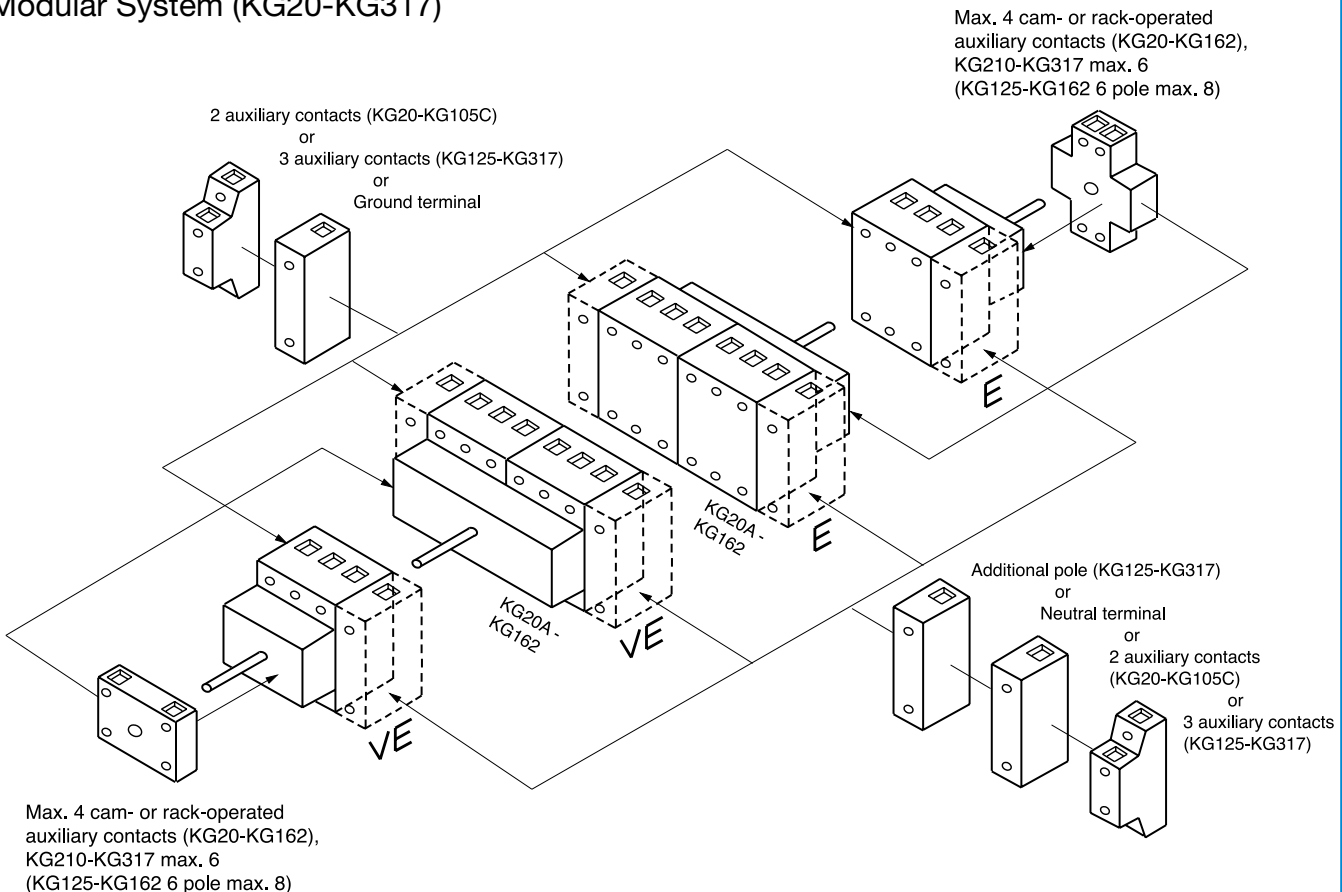









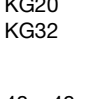
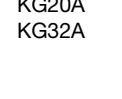
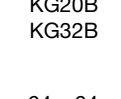

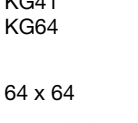
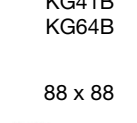

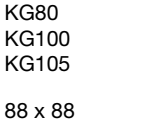
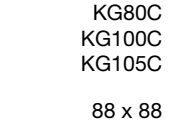
feature a four hole mounting. The flexibility of the KG's modular system offers maximum versatility for the modifying of switches in the field. Modules can easily be added to switches which have already been installed in equipment often without having to remove existing wiring. This modular design also minimizes the need for high inventory levels. Other important accessories such as make before break auxiliary contacts, additional box and bolt terminals, shaft extensions, door clutches, terminal covers and padlock devices enhance the flexibility and versatility of this proven line of switches.

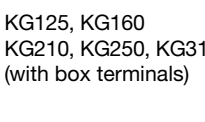
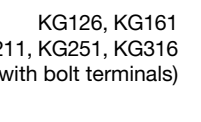
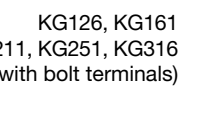
Modular System (KG20-KG317)

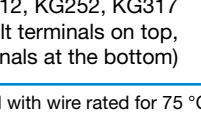
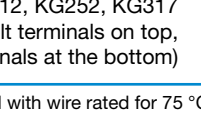

[< back to table of contents >](#)

Nominal Ratings

Face plate Frame mm	Typen	IEC 60947-3/VDE 0660 part 107			UL and Canada	
		Rated Values	Utilization Category	Ampere-Rating	Standard Motor Load DOL-Rating	
		Thermal Current I_U/I_{th} A	AC-23A kW	AC-3 A	3 x 240 V HP	3 x 480 V HP
48 x 48	 KG10A	20	5,5	3,7	2	3
64 x 64	 KG10B	20	5,5	3,7	2	3
30 x 30	 KG20	25	7,5	5,5	7,5	15
48 x 48	 KG20A	25	7,5	5,5	7,5	15
64 x 64	 KG20B	25	7,5	5,5	7,5	15
	 KG32	32	11	7,5	10	20
	 KG32A	32	11	7,5	10	20
	 KG32B	32	11	7,5	10	20
48 x 48	 KG41	40	15	11	15	25
64 x 64	 KG41B	40	15	11	15	25
	 KG64	63	22	18,5	15	30
	 KG64B	63	22	18,5	15	30
64 x 64	 KG80	80	30	22	25	50
88 x 88	 KG80C	80	30	22	25	50
	 KG100	100	37	30	25	50
	 KG100C	100	37	30	25	50
	 KG105	125	45	37	40	60
	 KG105C	125	45	37	40	60
88 x 88	 KG125, KG160	125	45	37	30	60
	 KG126, KG161	125	45	37	30	60
	 KG127, KG162	125	45	37	30	60
	 KG160	160	55	45	40	60
	 KG161	160	55	45	40	60
	 KG162	160	55	45	40	60
	 KG210, KG250, KG315 (with box terminals)	200	75	55	50	75
	 KG211, KG251, KG316 (with bolt terminals)	200	75	55	50	75
	 KG212, KG252, KG317 (bolt terminals on top, box terminals at the bottom)	200	75	55	50	75
88 x 88	 KG250	250	90	55	60	75
	 KG251	250	90	55	60	75
	 KG252	250	90	55	60	75
	 KG315	315	110	75	75	100
	 KG316	315	110	75	75	100
	 KG317	315	110	75	75	100

¹Valid when connected with wire rated for 75 °C.

How to order

Disconnectors and Main Switches according to IEC 60947-3 see Catalog 500

Three or four pieces of data (shown below) are required for ordering Blue Line Switch Disconnectors. Code numbers for ordering are shown in this catalog.

1. Type of Switch

The type of switch required may be easily selected by referring to the tables on pages 5 and 25 which show the thermal current and power rating of each switch. For further technical details, refer to pages 22/23 and 36/37.

2. Switch Function

The code numbers for the KG switches shown on pages 11-13 and on page 27 for the KH switches indicate the switch function, face plates and handles. Additional coding to modify the type and color of handle and face plate is explained below and on page 7.

3. Type of Mounting

Switch types and enclosures for the KG switches are shown on pages 8-10. The KH switches may be selected by referring to the table on page 26.

KG100

**K302
M004**

VE

4. Optional Extras

Pages 16-21 list optional extras and their coding for the KG switches. For the KH/KHR switches refer to pages 30-34. A table shows the different switch sizes in which the optional extra is available.

There are some optional extras which are available in a variety of programs. Additional ordering data may, therefore, be required.

Handles, Face plates and Optional Extras

Various standards for the KG switches are listed in the table on pages 8-10 and for the KH/KHR switches on page 26.

When a handle, face plate or optional extra is required but not covered by the standard code number, the code number for the selected component should be entered separately. A complete range of standard face plates are illustrated on pages 14/15 and 28/29. Non standard or special face plate engravings are available at extra cost.

How to order





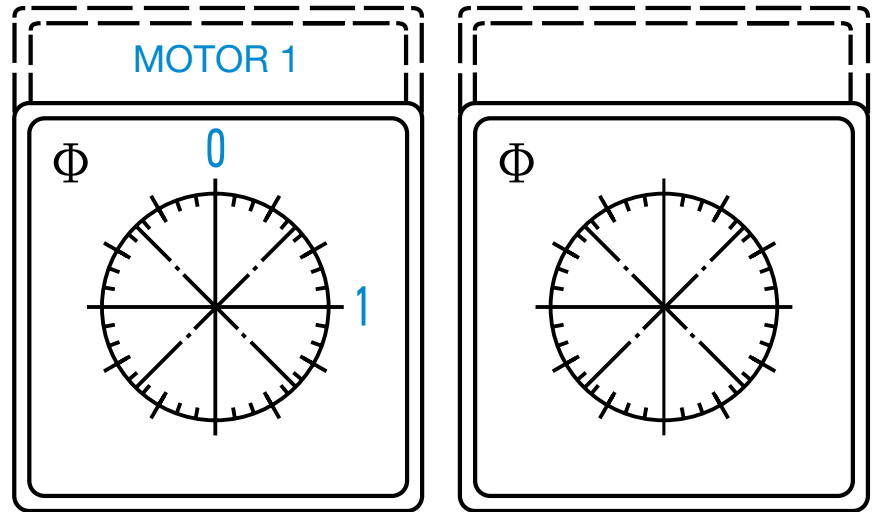



Ordering of Special Face plates

When ordering special escutcheon plates it is advisable to use our order form, as illustrated. **Example:** Customer's requirements are shown beside these two numbers with a digit number which represents the color combination required.



Order forms are available upon request.

Mounting	Type	Code
----------	------	------



	<p>Front mounting</p> <p>Two hole panel mounting, Protection IP 66/67</p>	<p>KG20 KG32</p>	<p>E</p>
	<p>Four hole panel mounting, Protection IP 66/67 Protection IP 66/67 Protection IP 66/67</p>	<p>KG10A KG41- KG100 KG160- KG315</p>	<p>E</p>
	<p>Single hole mounting 22 mm</p> <p>Without face plate, Protection IP 66/67/69k</p>	<p>KG10A KG20A KG32A</p>	<p>FT1</p>
	<p>With square face plate, Protection IP 66/67/69k</p>	<p>KG10A KG20A KG32A</p>	<p>FT2</p>
	<p>Base mounting</p> <p>Screw/Snap-on base mounting for track EN 50022, Protection IP 40</p>	<p>KG10A- KG317</p>	<p>VE</p>
	<p>Snap-on base mounting for track EN 50022, Protection IP 40</p>	<p>KG125- KG162</p>	<p>VE1</p>
	<p>Screw base mounting (KG20A-KG162) and Snap-on base mounting (KG20A-KG105) for track EN 50022. Face plate for 45 mm knock-out. Protection IP 40</p>	<p>KG20A KG32A KG41- KG64B KG80- KG105 KG125- KG162</p>	<p>VE2</p>
	<p>Snap-on base mounting for track EN 50022. Both the face plate for 45 mm standard knock-out and the handle are adjustable in height. Protection IP 40</p>	<p>KG10A</p>	<p>VE21</p>

[< back to table of contents >](#)

Plastic Enclosure Protection IP 66	Type	Code
	<p>The KL and CL enclosures are available in 3 sizes allowing for installation of 3, 4, 6 and 8 pole KG switches. The KL-series is made of strong durable plastic and offers high UV-resistance. All KL- and KS-enclosures are flame resistant in accordance with UL94V-0. The CL-series is especially designed for applications in an aggressive environment, such as oil, chemical substances and grease. Each enclosure has 2 knock-outs on top and bottom for metric thread according to EN 50262. Included in each enclosure is a ground and neutral terminal. One of these terminals must be eliminated if a 3 pole switch with lateral mounted auxiliary contacts or a 4 pole switch is installed.</p> <p>All enclosures can be supplied with a cover coupling for additional safety. Increased wiring space and mounting holes with slots are featured in this new line. These enclosures are also available for conduit entries for PG-thread.</p>	<p>KG20 KG32 KG20B KG32B KG41 KG64 KG41B KG64B KG80 KG100 KG105</p>
	<p>Without cover interlock</p>	<p>KL.0 CL.0</p>
	<p>With cover interlock (The enclosure can only be opened at 9 o'clock position)</p>	<p>KL.1 CL.1</p>
	<p>With cover interlock (The enclosure can only be opened at 12 o'clock position)</p>	<p>KL.2 CL.2</p>
	<p>KS and CS enclosures have a compact size which allows for the installation of a 3, 4 or 6 pole KG10 ON/OFF switch or a 3 pole KG20 ON/OFF switch. The design, options and mounting are the same as those of the KL and CL enclosures.</p>	<p>KG10 KG20</p>
	<p>Without cover interlock</p>	<p>KS50 CS50</p>
	<p>With cover interlock (The enclosure can only be opened at 9 o'clock position)</p>	<p>KS51 CS51</p>
	<p>With cover interlock (The enclosure can only be opened at 12 o'clock position)</p>	<p>KS52 CS52</p>

[< back to table of contents >](#)

Plastic Enclosure with Ground Terminal Protection IP 65 resp. IP 54	Threads	Type	Code
---	---------	------	------

 <p>KG20A, KG32A, KG41, KG64 3 and 4 pole (ON/OFF Switches) Protection IP 65</p>	<p>Conduit entries with NPT-thread, Protection 65</p>		<p>KG20A KG32A KG41 KG64</p>	<p>PFA4 PFA PFD4 PFD</p> <p>PFB4 PFB PFE4 PFE</p> <p>PFC4 PFC PFF4 PFF</p>		
	Without cover coupling	1/2" 3/4"				
	And for switches with cam-operated auxiliary contacts	1/2" 3/4"				
	With cover coupling	1/2" 3/4"				
	And for switches with cam-operated auxiliary contacts	1/2" 3/4"				
	Without cover coupling, combined with padlock device V840A	1/2" 3/4"				
	And for switches with cam-operated auxiliary contacts	1/2" 3/4"				
	<p>Conduit entries with NPT-thread, Protection 54</p>				<p>KG20B KG32B KG41B KG64B KG80 KG100</p>	<p>PFA5 PFA PFD5 PFD</p> <p>PFB5 PFB PFE5 PFE</p> <p>PFC5 PFC PFF5 PFF</p>
	Without cover coupling	3/4" 1"				
	And for switches with cam-operated auxiliary contacts	3/4" 1"				
With cover coupling	3/4" 1"					
And for switches with cam-operated auxiliary contacts	3/4" 1"					
Without cover coupling, combined with padlock device V840A	3/4" 1"					
And for switches with cam-operated auxiliary contacts	3/4" 1"					
<p>These enclosures are also available with PG-, BSI- or metric ISO-thread on request.</p>						
 <p>KG80, KG100 3 and 4 pole¹ (ON/OFF Switches) KG20B, KG32B, KG41B, KG64B 6 and 8 pole (ON/OFF Switches) 3 and 4 pole (Double-throw Switches) Protection IP 54 On top and at the bottom an additional conduit entry .63"</p>						

[< back to table of contents >](#)

¹For switches with cam-operated auxiliary contacts only 3 pole.

Function	KG10A	KG10B	KG20 KG32	KG20A KG32A	KG20B KG32B	KG41 KG64	KG41B KG64B	KG80 KG100 KG105	KG80C KG100C KG105C	KG125- KG317	Escutch. Plate	Code
----------	-------	-------	--------------	----------------	----------------	--------------	----------------	------------------------	---------------------------	-----------------	-------------------	------

ON/OFF Switches 3 pole

Types of Mounting

Without auxiliary contacts	E FT1 FT2 VE VE21 KS. ²	E VE VE	E VE KL. KS. ¹	E FT1 FT2 VE VE2 PF..	E VE VE	E VE VE2 KL. PF..	E VE VE2 KL. PF.. ⁴	E VE VE2 KL. PF.. ⁴	E VE VE2 KL. PF.. ⁴	E VE VE1 ³ VE2 ³		K300
With cam/rack-operated auxiliary contact 1 NO	E FT1 FT2 VE VE21 KS. ²	E VE VE	E VE KL.	E FT1 FT2 VE VE2 PF..	E VE VE	E VE VE2 KL. PF..	E VE VE2 KL. PF.. ⁴	E VE VE2 KL. PF.. ⁴	E VE VE2 KL. PF.. ⁴	E VE VE1 ³		K301
With cam/rack-operated auxiliary contacts 1 NO and 1 NC	E FT1 FT2 VE VE21 KS. ²	E VE VE	E VE KL.	E FT1 FT2 VE VE2 PF..	E VE VE	E VE VE2 KL. PF..	E VE VE2 KL. PF.. ⁴	E VE VE2 KL. PF.. ⁴	E VE VE2 KL. PF.. ⁴	E VE VE1 ³		K302
With cam/rack-operated auxiliary contacts 2 NO			E VE KL.	E FT1 FT2 VE VE2 PF..	E VE VE	E VE VE2 KL. PF..	E VE VE2 KL. PF.. ⁴	E VE VE2 KL. PF.. ⁴	E VE VE2 KL. PF.. ⁴	E VE VE1 ³		K312
With lateral mounted auxiliary contacts 1 NO and 1 NC			E VE KL.	E FT1 FT2 VE VE2 PF..	E VE VE	E VE VE2 KL. PF..	E VE VE2 KL. PF.. ⁴	E VE VE2 KL. PF.. ⁴	E VE VE2 KL. PF.. ⁴			K304
With GRD-terminal			E VE	E FT1 FT2 VE VE2	E VE	E VE VE2	E VE VE2	E VE VE2	E VE VE2	E VE VE1 ³ VE2 ³		K305
With GRD- and N-terminal			E VE	E FT1 FT2 VE VE2	E VE	E VE VE2	E VE VE2	E VE VE2	E VE VE2	E VE VE1 ³ VE2 ³		K307

[< back to table of contents >](#)

¹Only for switch type KG20. ²When using KS. the switch type changes to KG10. ³Only for switch types KG125-KG162. ⁴Only for switch types KG80 and KG100.

Function	KG10A	KG10B	KG20 KG32	KG20A KG32A	KG20B KG32B	KG41 KG64	KG41B KG64B	KG80 KG100 KG105	KG80C KG100C KG105C	KG125- KG317	Escutch. Plate	Code
----------	-------	-------	--------------	----------------	----------------	--------------	----------------	------------------------	---------------------------	-----------------	-------------------	------

ON/OFF Switches 4 pole

Types of Mounting

Without auxiliary contacts	E FT1 FT2 VE VE21 KS. ¹	E VE	E VE KL.	E FT1 FT2 VE VE2 PF..	E VE	E VE VE2 KL. PF..	E VE VE2 KL. PF. ³	E VE VE2 KL. PF. ³	E VE VE2 KL. PF. ³	E VE VE1 ² VE2 ²		K400
With cam-operated auxiliary contact 1 NO			E VE KL.	E FT1 FT2 VE VE2 PF..	E VE	E VE VE2 KL. PF..	E VE VE2 KL. PF.	E VE VE2 KL. PF.	E VE VE2 KL. PF.	E VE VE1 ²		K401
With cam-operated auxiliary contacts 1 NO and 1 NC	E FT1 FT2 VE VE21 KS. ¹	E VE	E VE KL.	E FT1 FT2 VE VE2 PF..	E VE	E VE VE2 KL. PF..	E VE VE2 KL. PF.	E VE VE2 KL. PF.	E VE VE2 KL. PF.	E VE VE1 ²		K402
With lateral mounted auxiliary contacts 1 NO and 1 NC			E VE	E FT1 FT2 VE VE2 PF..	E VE	E VE VE2	E VE VE2 PF. ³	E VE VE2 PF. ³	E VE VE2 PF. ³	E VE VE2 PF. ³		K404

[< back to table of contents >](#)

ON/OFF Switches 6 pole

Without auxiliary contacts	E FT1 FT2 VE VE21 KS. ¹	E VE		E VE VE2	E VE KL. PF..		E VE VE2 KL. PF..	E VE VE2 KL. PF..	E VE VE2 KL. PF..	E ² VE ² VE1 ²		K600
With cam-operated auxiliary contact 1 NO				E VE VE2	E VE KL. PF..		E VE VE2 KL. PF..	E VE VE2 KL. PF..	E VE VE2 KL. PF..	E ² VE ² VE1 ²		K601
With cam-operated auxiliary contacts 1 NO and 1 NC	E FT1 FT2 VE VE21 KS. ¹	E VE		E VE VE2	E VE KL. PF..		E VE VE2 KL. PF..	E VE VE2 KL. PF..	E VE VE2 KL. PF..	E ² VE ² VE1 ²		K602

¹When using KS. the switch type changes to KG10. ²Only for switch types KG125-KG162. ³Only for switch types KG80 and KG100.

Function	KG10A	KG10B	KG20A KG32A	KG20B KG32B	KG41B KG64B	KG80 KG100 KG105	KG80C KG100C KG105C	KG125- KG162	Escutch. Plate	Code
----------	-------	-------	----------------	----------------	----------------	------------------------	---------------------------	-----------------	-------------------	------

ON/OFF Switches 8 pole

Types of Mounting

Without auxiliary contacts			E VE VE2	E VE KL. PF..	E VE VE2 KL. PF..	E VE VE2	E VE	E VE VE1		K800
----------------------------	--	--	----------------	------------------------	-------------------------------	----------------	---------	----------------	--	-------------

Double-throw Switches 3 pole

Without auxiliary contacts			E VE VE2	E VE KL. PF..	E VE VE2 KL. PF..	E VE VE2	E VE	E VE VE1		K900
----------------------------	--	--	----------------	------------------------	-------------------------------	----------------	---------	----------------	--	-------------

Double-throw Switches 4 pole

Without auxiliary contacts			E VE VE2	E VE KL. PF..	E VE VE2 KL. PF..	E VE VE2	E VE	E VE VE1		K950
----------------------------	--	--	----------------	------------------------	-------------------------------	----------------	---------	----------------	--	-------------

[< back to table of contents >](#)

Connection Diagrams

ON/OFF Switches 3 pole (with cam-operated auxiliary contacts)

ON/OFF Switches 4 pole (with cam-operated auxiliary contacts)

ON/OFF Switches 6 pole (with cam-operated auxiliary contacts)

With lateral mounted auxiliary contacts

Mounting E, FT1, FT2

With lateral mounted auxiliary contacts

VE, VE2, KL., PF..

With lateral mounted auxiliary contacts

Mounting E, FT1, FT2

With lateral mounted auxiliary contacts

VE, VE2

ON/OFF Switches 8 pole

Double-throw Switches 3 pole

Double-throw Switches 4 pole

Square and rectangular face plates are available for each size of switch. The face plate consists of a frame and a faceplate having the switch position which is then embossed with hot-foil backing. The face plate frame is an essential part of the switch and serves as a bearing surface for the handle. If the switch is to be mounted without an face plate we would recommend the handle bearing plate T100-04, which is available for switch types KG10B, KG20B, KG32B, KG41B, KG80, KG100, KG105, KG80C, KG100C, KG105C and KG125-KG317. Face plates with special lettering are also available upon request.





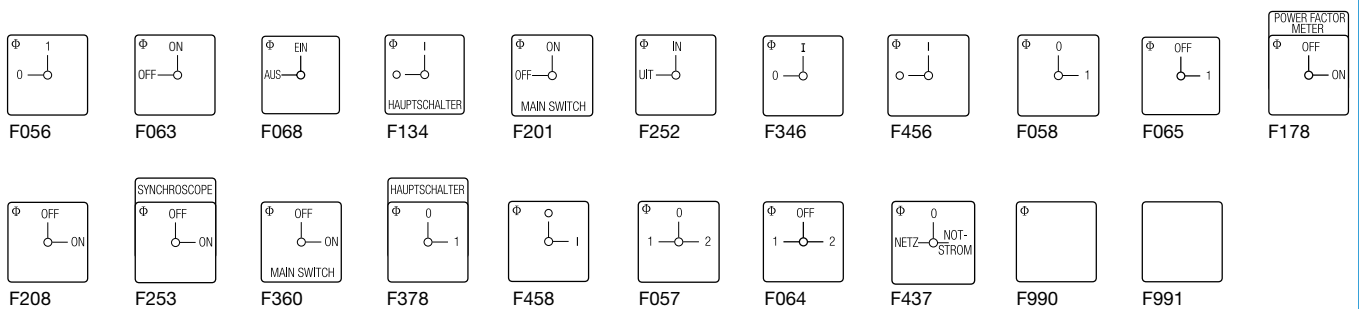



Standard Face plates



¹Not available for switch types KG20 and KG32.

Handles



KG Switches

Type	Color	Code	KG20 KG32	KG10A- KG64	KG10B- KG105	KG80C- KG105C	KG125- KG162	KG210- KG317
I-Handle 	black red	G251 G252	● ●	● ●	● ●	● ●	● ●	— —
B-Handle 	black red	G521 G522	— —	● ●	● ●	— —	— —	— —
R-Handle 	black red	G001 G002	— —	● ●	● ●	● ●	● ●	— —
F-Handle 	black red	G221 G222	● ●	● ●	● ●	● ●	● ●	— —
L-Handle 	black red	G501 G502	— —	— —	● ●	— —	— —	— —
P-Handle  KG10A-KG64 KG10B-KG317	black red	G211 G212	— —	● ●	● ●	● ●	● ●	● ●
K-Handle 	black red	G411 G412	— —	— —	● ●	● ●	● ●	● ●



[< back to table of contents >](#)

Protective Covers, Auxiliary Contacts	Type	Code
--	------	------

Protective Covers



	For 3 resp. 4 main contacts	KG10A KG10B	M160/A12 K2
	For 3 main contacts with box terminal with bolt terminal	KG20- KG315 KG126 KG161 KG211 KG251 KG316	M160/3. M160/33 M160/31
	For 4 main contacts with box terminal with bolt terminal	KG20- KG315 KG126 KG161 KG211 KG251 KG316	M160/4. M160/43 M160/41







Cam- and rack-operated Auxiliary Contacts (mounting only at factory)

	Cam-operated auxiliary contacts Up to 4 cam-operated auxiliary contacts can be added to all switches.	KG20- KG105C	M510A
	Select between a contact system with a rigid contact bridge for excellent AC-15 making and breaking capabilities or a H-bridge design with "cross-wire" contacts for low voltages and currents (mounting E from KG41 and mounting VE from KG80). The contact systems with gold contacts or gold-plated contacts allow for use in aggressive environments also. Special programs are also available upon request.		
	Rack-operated auxiliary contacts Switch types KG125-KG162 can be supplied with up to 4 auxiliary contacts, KG210-KG317 with up to 6 auxiliary contacts.	KG125- KG317	M510B
	Ordering data:	Quantity and operation of the auxiliary contacts and type of the contact system.	

[< back to table of contents >](#)

Lateral mounted Auxiliary Contacts

	Lateral mounted auxiliary contacts with 1 NO and 1 NC.	KG20- KG105C	H010/A11-E H010/A11-VE H010/B11-E H010/B11-VE																										
	<table border="0"> <tr> <td></td> <td colspan="2" style="text-align: center;">Terminal numbers Attachment</td> <td></td> </tr> <tr> <td>Standard contacts (nonoverlapping)</td> <td>left</td> <td>right</td> <td></td> </tr> <tr> <td>For mounting E, FT1 and FT2</td> <td>(33-34, 41-42)</td> <td>(53-54, 61-62)</td> <td></td> </tr> <tr> <td>For mounting VE, VE2, KL. and PF..</td> <td>(31-32, 43-44)</td> <td>(51-52, 63-64)</td> <td></td> </tr> <tr> <td>Overlapping contacts</td> <td></td> <td></td> <td></td> </tr> <tr> <td>For mounting E, FT1 and FT2</td> <td>(33-34, 41-42)</td> <td>(53-54, 61-62)</td> <td></td> </tr> <tr> <td>For mounting VE, VE2, KL. and PF..</td> <td>(31-32, 43-44)</td> <td>(51-52, 63-64)</td> <td></td> </tr> </table>			Terminal numbers Attachment			Standard contacts (nonoverlapping)	left	right		For mounting E, FT1 and FT2	(33-34, 41-42)	(53-54, 61-62)		For mounting VE, VE2, KL. and PF..	(31-32, 43-44)	(51-52, 63-64)		Overlapping contacts				For mounting E, FT1 and FT2	(33-34, 41-42)	(53-54, 61-62)		For mounting VE, VE2, KL. and PF..	(31-32, 43-44)	(51-52, 63-64)
	Terminal numbers Attachment																												
Standard contacts (nonoverlapping)	left	right																											
For mounting E, FT1 and FT2	(33-34, 41-42)	(53-54, 61-62)																											
For mounting VE, VE2, KL. and PF..	(31-32, 43-44)	(51-52, 63-64)																											
Overlapping contacts																													
For mounting E, FT1 and FT2	(33-34, 41-42)	(53-54, 61-62)																											
For mounting VE, VE2, KL. and PF..	(31-32, 43-44)	(51-52, 63-64)																											
	Lateral mounted auxiliary contacts with 2 NO and 1 NC.	KG125- KG317	H010/A21-E H010/A21-VE H010/B21-E H010/B21-VE																										
	<table border="0"> <tr> <td></td> <td colspan="2" style="text-align: center;">Terminal numbers Attachment</td> <td></td> </tr> <tr> <td>Standard contacts (nonoverlapping)</td> <td>left</td> <td>right</td> <td></td> </tr> <tr> <td>For mounting E</td> <td>(013-014, 023-024, 031-032)</td> <td>(043-044, 053-054, 061-062)</td> <td></td> </tr> <tr> <td>For mounting VE</td> <td>(011-012, 023-024, 033-034)</td> <td>(041-042, 053-054, 063-064)</td> <td></td> </tr> <tr> <td>Overlapping of 1 NO and 1 NC</td> <td></td> <td></td> <td></td> </tr> <tr> <td>For mounting E</td> <td>(013-014, 023-024, 031-032)</td> <td>(043-044, 053-054, 061-062)</td> <td></td> </tr> <tr> <td>For mounting VE</td> <td>(011-012, 023-024, 033-034)</td> <td>(041-042, 053-054, 063-064)</td> <td></td> </tr> </table>			Terminal numbers Attachment			Standard contacts (nonoverlapping)	left	right		For mounting E	(013-014, 023-024, 031-032)	(043-044, 053-054, 061-062)		For mounting VE	(011-012, 023-024, 033-034)	(041-042, 053-054, 063-064)		Overlapping of 1 NO and 1 NC				For mounting E	(013-014, 023-024, 031-032)	(043-044, 053-054, 061-062)		For mounting VE	(011-012, 023-024, 033-034)	(041-042, 053-054, 063-064)
	Terminal numbers Attachment																												
Standard contacts (nonoverlapping)	left	right																											
For mounting E	(013-014, 023-024, 031-032)	(043-044, 053-054, 061-062)																											
For mounting VE	(011-012, 023-024, 033-034)	(041-042, 053-054, 063-064)																											
Overlapping of 1 NO and 1 NC																													
For mounting E	(013-014, 023-024, 031-032)	(043-044, 053-054, 061-062)																											
For mounting VE	(011-012, 023-024, 033-034)	(041-042, 053-054, 063-064)																											



Ground and Neutral Terminals	Type	Code	Additional Main Contacts	Type	Code																
<p>Ground terminal</p>  	KG20- KG32B	K0 H052/A	 <p>Terminals for Control Circuit</p>  <p>Max. Permissible Wire Gage Single-core or Flexible wire stranded wire</p> <table border="1"> <tr> <td>2,5 mm² AWG12</td> <td>2,5 mm² AWG14</td> <td>KG41- KG64B</td> <td>K1B D220 KS</td> </tr> <tr> <td>2,5 mm² AWG12</td> <td>2,5 mm² AWG14</td> <td>KG80- KG105C</td> <td>K2B D520 KSA</td> </tr> <tr> <td>4 mm² AWG10</td> <td>4 mm² AWG12</td> <td>KG125- KG162</td> <td>K3A D720 KS</td> </tr> <tr> <td>4 mm² AWG10</td> <td>4 mm² AWG12</td> <td>KG210- KG317</td> <td>K3B D520 KS</td> </tr> </table> <p>Wiring Aid</p>  <p>Ordering data: Switch moun- ting.</p>	2,5 mm ² AWG12	2,5 mm ² AWG14	KG41- KG64B	K1B D220 KS	2,5 mm ² AWG12	2,5 mm ² AWG14	KG80- KG105C	K2B D520 KSA	4 mm ² AWG10	4 mm ² AWG12	KG125- KG162	K3A D720 KS	4 mm ² AWG10	4 mm ² AWG12	KG210- KG317	K3B D520 KS	KG125 KG126 KG127	K3 H050/P¹ K3 H050/Q¹ K3 H050/R¹
	2,5 mm ² AWG12	2,5 mm ² AWG14		KG41- KG64B	K1B D220 KS																
	2,5 mm ² AWG12	2,5 mm ² AWG14		KG80- KG105C	K2B D520 KSA																
	4 mm ² AWG10	4 mm ² AWG12		KG125- KG162	K3A D720 KS																
	4 mm ² AWG10	4 mm ² AWG12		KG210- KG317	K3B D520 KS																
	KG41- KG64B	K1 H052/B		KG160 KG161	K3 H050/S¹ K3 H050/T¹ K3 H050/U¹																
	KG80- KG105C	K2 H052/C		KG210 KG250 KG315	K3 H050/G¹ K3 H050/H¹ K3 H050/J¹																
	KG125 KG160	K3 H052/H¹		KG211 KG251																	
	KG126 KG161	K3 H052/J¹		KG212 KG252																	
	KG127 KG162	K3 H052/K¹		KG316 KG317	K3 H050/K¹ K3 H050/L¹ K3 H050/M¹																
	KG210 KG250 KG315	K3 H052/D¹																			
	KG211 KG251	K3 H052/E¹																			
	KG212 KG252	K3 H052/F¹																			
	KG316 KG317	K3 H052/L¹ K3 H052/M¹																			
	<p>Neutral terminal</p>  	KG20- KG32B		K0 H053/A																	
KG41- KG64B		K1 H053/B																			
KG80- KG100C		K2 H053/C																			
KG125 KG160		K3 H053/H¹																			
KG126 KG161		K3 H053/J¹																			
KG127 KG162		K3 H053/K¹																			
KG210 KG250 KG315		K3 H053/D¹																			
KG211 KG251		K3 H053/E¹																			
KG212 KG252		K3 H053/F¹																			
KG316 KG317		K3 H053/L¹ K3 H053/M¹																			

< back to table of contents >

¹Mounting only at factory.

Shaft Extensions, Simplified Door Clutch	Type	Code
--	------	------

Shaft Extensions

	<p>With asymmetric profile Shaft length not adjustable</p>	<p>KG10B KG20B, KG32B KG41B- KG105C</p>	<p>L100</p>
	<p>Shaft with adjustable length with set screw with shear ring</p>	<p>KG10A KG20A, KG32A KG41-KG317</p>	<p>M004D M004</p>
	<p>With square profile Shaft length not adjustable</p>	<p>KG10B KG20B, KG32B KG41B- KG105C</p>	<p>L100A</p>
	<p>Shaft with adjustable length with set screw with clamping bushing</p>	<p>KG41B-KG317 KG125-KG317</p>	<p>M004E M004A</p>
<p>Ordering data:</p>	<p>Free shaft length or dimension from mounting surface to cover.</p>		



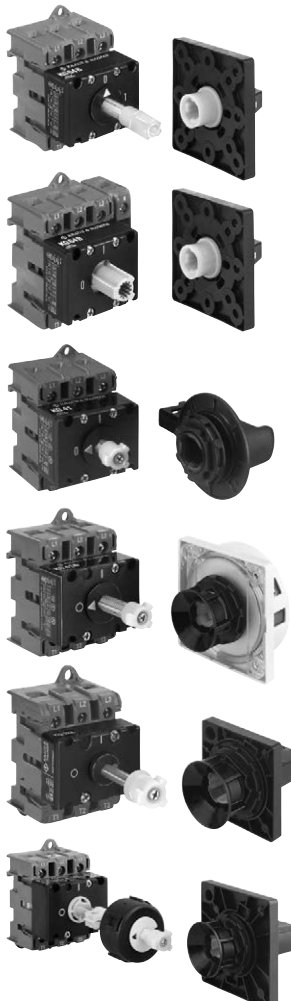

Simplified Door Clutch

	<p>The simplified door clutches are utilized primarily when the switch is mounted to the bottom of the enclosure and the handle and face plate are mounted on the cover.</p>		
	<p>With shaft extension Front protection IP 40 Front protection IP 65</p>	<p>KG10A KG20A, KG32A KG41B-KG105</p>	<p>M290/A3 M290/A3.EF¹</p>
	<p>With profile extension parts Front protection IP 65</p>	<p>KG41B-KG105</p>	<p>M290/A1.EF</p>
	<p>With padlock device, single hole mounting 22 mm, protection IP 66. An additional aluminum shaft extension is required.</p>		
	<p>Loc bar is accessible from 3 o'clock which achieve a compact design.</p>	<p>KG10B KG20B, KG32B KG41B-KG105, KG125-KG317²</p>	<p>V840E</p>
	<p>The cover disc is available in black, yellow and electro-gray. The handle may be supplied in black, red and electro-gray.</p>	<p>KG10B KG20B, KG32B KG41B-KG105</p>	<p>V840G V840F</p>
	<p>Operation of the locking bar from the front. Available in black, red and electro-gray.</p>	<p>KG10A KG20A, KG32A KG41, KG64 KG10B KG20B, KG32B KG41B-KG105</p>	<p>V845</p>
<p>Centering device for simplified door clutches with single hole mounting and shaft extension Misalignment between the shaft and mounting are compensated in all 4 directions.</p>	<p>KG10B KG20B, KG32B KG41B-KG105</p>	<p>M600</p>	
<p>Ordering data:</p>	<p>Free shaft length or dimension from face of the switch to the cover and color selection.</p>		

¹Available for switch types KG10A, KG20A and KG32A. ²Only for ON/OFF switches 3 and 4 pole.

Door Clutches	Type	Code
	<p>The M280 door clutch has an adjustable shaft and can be supplied with an interlock device.</p> <p>With protected profile shaft fixation with set screw Front protection IP 40 Front protection IP 66/67 shaft fixation with shear ring Front protection IP 40 Front protection IP 66/67</p> <p>Without protected profile Front protection IP 40 Front protection IP 65</p> <p>Handle lockable with padlocks Protection IP 66 The face plate is available in black, yellow and alu. The handle may be supplied in black and red.</p> <p>The M700 is a padlock door clutch and a mechanical interlocking safety device. Using the device the electrical panel may be opened only when the switch is in the OFF position and no padlock is fitted. Note: Only in the ON position can knowledgeable personnel using a simple tool to defeat the interlock. The M700's flexibility allows for successful installation with as much as + or - 5 mm of misalignment between the shaft and door.</p> <p>Standard handle and standard face plate Protection IP 66 The M700's flexibility allows for successful installation with as much as + or - 5 mm of misalignment between the shaft and door.</p> <p>Unlock insert for the M700 to open the door in ON-position. (After the locking has been made inactive, it is necessary to take effective precautions against an opening of the door by unauthorized persons.)</p> <p>The M800 door clutch utilizes a simple and robust design and features a compact size. It has an interlock in the ON-position while a padlock can be fitted in the OFF-position. The door clutch may be opened only if the switch is in the OFF-position. In special cases, however, authorized people have a requirement to open the door, even if the switch is in the ON-position. Further characteristics are the single hole mounting with IP 66/67 protection degree, as well as the Accepted Misalignment up to ± 3 mm horizontally and ± 5 mm vertically. Maximum 3 padlocks with a minimum shackle diameter from 5 up to 8 mm are possible.</p>	<p>KG10A KG20A KG32A KG41B KG64B KG80 KG100 KG105 KG125- KG317</p> <p>M280E M280E/.EF</p> <p>M280D M280D/.EF</p> <p>KG41 KG64</p> <p>M280B/. M280B/.EF</p> <p>KG10B KG20B KG32B KG41B KG64B KG80 KG100 KG105 KG125- KG317</p> <p>M700/.</p> <p>M701</p> <p>S1D M700 29</p> <p>M810/. M800/.</p>
<p>Ordering data:</p>	<p>Dimension from face of the switch to the cover or dimension from mounting surface to cover, the interlock program and the color selection.</p>	

[< back to table of contents >](#)

Padlock Devices	Type	Code
 <p>The padlock device is an integral part of the switch.</p> <p>For 2 padlocks Operation of the locking bar from the bottom. Available in black, red and electro-gray.</p>	<p>KG10A KG20A, KG32A KG10B KG20B, KG32B KG41-KG105 KG125-KG162</p>	<p>V840A</p>
 <p>For 4 padlocks Operation of the locking bar from the front. Available in black, red and electro-gray.</p>	<p>KG10A KG20A, KG32A KG41, KG64 KG10B KG20B, KG32B KG41B, KG64B KG80-KG105 KG80C- KG105C KG125-KG317</p>	<p>V845</p>
 <p>For mounting VE2 Operation of the locking bar from the front.</p> <p>For distribution box with 70 mm depth.</p>	<p>KG10A KG20A, KG32A KG41, KG64 KG80-KG105</p>	<p>V840B</p>
 <p>Padlock device with integrated F- or B-handle. The cover disc is available in black, yellow and electro-gray. The handle may be supplied in black, red and electro-gray.</p>	<p>KG20A, KG32A KG41, KG64</p>	<p>V840H/..E</p>
<p>For 2 padlocks with F-handle</p>	<p>KG10A KG20A, KG32A KG41, KG64</p>	<p>V840D</p>
<p>For 3 padlocks with F-handle</p>	<p>KG80C- KG105C KG125-KG162</p>	<p>V840G</p>
<p>For 3 padlocks with F-handle with B-handle</p>	<p>KG10B KG20B, KG32B KG41B, KG64B KG80-KG105</p>	<p>V840G/B</p>
<p>For 4 padlocks with F-handle with B-handle</p>	<p>KG80-KG105</p>	<p>V840F/F V840F/B</p>
 <p>Padlock device for switches with base mounting for locking when control cabinet is opened.</p> <p>Padlock devices with simplified door clutch and single hole mounting see page 18.</p>	<p>KG20B, KG32B KG41B, KG64B KG80-KG105 KG125-KG317</p>	<p>V840VE</p>
<p>Ordering data:</p>	<p>For V840 and V845 color selection required.</p>	

[< back to table of contents >](#)

Additional Module for Motor Control Center (MCC), Angular drive	Type	Code
---	------	------

Angular drive

	KG125- KG317 ¹	M330
---	------------------------------	-------------

¹Only for ON/OFF switches 3 and 4 pole.

Selection Data	KG10	KG20	KG32	KG41	KG64	KG80	KG100	KG105	KG125	KG160	KG210	KG250	KG315
	KG10A	KG20A	KG32A	KG41B	KG64B	KG80C	KG100C	KG105C	KG126	KG161	KG211	KG251	KG316
	KG10B	KG20B	KG32B						KG127	KG162	KG212	KG252	KG317

Rated Insulation Voltage U_i IEC/VDE ¹ UL/Canada CEE/NEMKO	V	690	690	690	690	690	690	690	690	1000 ²	1000 ²	1000 ²	1000 ²	1000 ²			
	V	300	600	600	600	600	600	600	600	600	600	600	600	600			
	V	400	500	500	500	500	500	500	-	-	-	-	-	-			
Rated Impulse Withstand Voltage U_{imp} ¹	kV	4	6	6	6	6	6	6	6	8	8	8	8	8			
Rated Thermal Current IEC/VDE $I_{u, open} = I_{th}$ $I_{the, enclosed}$ UL/Canada ON/OFF function UL/Canada Double-throw function	A	20	25	32	40	63	80	100	125	125	160	200	250	315			
	A	20	25	32	40	63	80	100	125	125	160	200	250	315			
	A	20	25	30	40	60	80 ³	100 ³	125	150 ³	200 ³	200 ³	250 ³	300 ³			
	A	20	25	30	40	60	80 ³	100 ³	115	125 ³	160 ³	-	-	-			
Rated Operational Current I_e AC-21A Switching of resistive loads, including moderate overloads	A	20	25	32	40	63	80	100	125	125	160	200	250	315			
AC-22A Switching of combined resistive or low inductive loads, including moderate overloads	IEC/VDE	220 V-500 V	A	20	20	32	40	63	80	100	125	125	160	200	250		
	UL/Canada	660 V-690 V	A	16	20	32	40	55	65	85	90	100	100	125	140		
Ampere-Rating ON/OFF function Double-throw function Resistive or low inductive loads	UL/Canada ⁴	600 V	A	20 ⁷	25	30	40	60	80 ³	100 ³	125	150 ³	200 ³	200 ³	250 ³	300 ³	
	UL/Canada ⁴	600 V	A	20 ⁷	25	30	40	60	80 ³	100 ³	115	125 ³	160 ³	-	-	-	
Rated Utilization Category AC-3 Direct-on-line starting	IEC/VDE	3 phase	220 V-240 V	kW	2,2	4	5,5	7,5	11	15	18,5	22	22	30	37	37	45
		3 pole	380 V-440 V	kW	3,7	5,5	7,5	11	18,5	22	30	37	37	45	55	55	75
			500 V	kW	3,7	5,5	7,5	15	22	30	37	45	45	55	75	75	90
			690 V	kW	3,7	5,5	7,5	11	15	18,5	22	22	30	37	40	40	45
AC-23A Frequent switching of motors or other high inductive loads	IEC/VDE	3 phase	220 V-240 V	kW	3	5,5	5,5	7,5	11	18,5	22	25	30	30	37	37	55
		3 pole	380 V-440 V	kW	5,5	7,5	11	15	22	30	37	45	45	55	75	90	110
			500 V	kW	5,5	7,5	11	18,5	30	37	45	55	55	75	90	110	132
			690 V	kW	5,5	7,5	11	15	18,5	22	30	30	37	37	45	45	45
DOL-Rating Standard motor load (similar AC-3)	UL/Canada ⁴	3 phase	120 V	HP	1	2	3	5	5	10	10	15	15	20	25	30	40
		3 pole	240 V	HP	2	7,5	10	15	15	25	25	40	30	40	50	60	75
			480 V	HP	-	15	20	25	30	50	50	60	60	60	75	75	100
			600 V	HP	-	20	25	30	40	50	50	50	60	60	75	75	100
Power loss per contact at I_u Resistance to vibration ⁵ Resistance to shock ⁵	W	0,9	0,7	1,1	1	2,2	1,7	2,4	3,8	3,1	5	5	8	12,7			
	C	A	A	A	A	A	A	A	A	C	C	C	C	C			
	C	B	B	B	B	B	B	B	B	C	C	C	C	C			
Short Circuit Protection Max. fuse size Rated short-time withstand current (1 s-current)	(gG-characteristic)	A	20	35	35	50	63	80	100	125	125	160	200	250	315		
		A	130	350	430	500	580	1600	1850	2000	2500	3000	4000	4600	5800		
Max. Permissible Wire Gage - Use copper wire only For box terminal	Single-core or stranded wire	mm ²	2,5	6	6	16	16	50	50	50	95	95	185	185	185		
		AWG	12	10	10	6	6	1/0	1/0	1/0	3/0	3/0	-	-	-		
		MCM	-	-	-	-	-	-	-	-	-	-	350	350	350		
	Flexible wire sleeving in accordance with DIN 46228	mm ²	2,5	4	4	10	10	35	35	35	70	70	120	120	120		
	Flexible wire without sleeve	mm ²	2,5	4	4	10	10	35	35	35	70	70	150	150	150		
		AWG	12	10	10	6	6	2	2	2	2/0	2/0	-	-	-		
		MCM	-	-	-	-	-	-	-	-	-	-	300	300	300		
Cable lug or track must accept connection screw	Max. width	mm	-	-	-	-	-	-	-	-	M10 x 20	M10 x 20	M12 x 20	M12 x 20	M12 x 20		
	Max. width with protective cover	mm	-	-	-	-	-	-	-	-	20	20	25	25	25		
		mm	-	-	-	-	-	-	-	-	25	25	34	34	34		
Min. Ambient Temperature Max. Ambient Temperature ⁶	open at 100 % I_u/I_{th} enclosed at 100 % I_{the}	-5 °C 50 °C during 24 hours with peaks up to 55 °C 35 °C during 24 hours with peaks up to 40 °C															

[< back to table of contents >](#)

¹Valid for lines with common neutral termination, overvoltage category III, pollution degree 3. Values for other supply systems on request. ²Suitable for no load switching applications (AC-20A) above 690 V. ³Valid when connected with wire rated for 75 °C. ⁴International Standards and Approvals, refer to page 24. ⁵A: min. 4 g, 2-100 Hz, 1,6 mm. B: min. 6 g, 6 ms. C: on request. ⁶Storage temperature: -40 °C to 85 °C (in case of temperature below -5 °C no shock load permissible). ⁷Max. 277 V.

DC Switching Capacity								Rated Operational Current I_e / A																		
No. of series connected contacts, total voltage / V								KG20 for utilization category						KG32 for utilization category						KG41 for utilization category						
								DC-21		DC-22		DC-23		DC-21		DC-22		DC-23		DC-21		DC-22		DC-23		
1	2	3	4	5	6	7	8	A	B	A	B	A	B	A	B	A	B	A	B	A	B	A	B	A	B	
80	160	240	320	400	480	560	640	25	25	25	25	21	21	32	32	32	32	30	30	40	40	40	40	40	40	
110	220	330	440	550	660	770	880	25	25	18	18	12	12	32	32	25	25	18	18	40	40	32	32	25	25	
140	280	420	560	700	840	1000	-	21	21	12	12	8	8	28	28	18	18	12	12	28	28	20	20	14	14	
170	340	510	680	850	1000	-	-	-	20	-	9	-	5	-	25	-	12	-	8	-	25	-	12	-	-	10
200	400	600	800	1000	-	-	-	-	18	-	6	-	3	-	23	-	8	-	5	-	23	-	8	-	-	5
230	460	690	920	1000	-	-	-	-	11	-	4	-	2	-	15	-	5	-	3	-	10	-	5	-	-	3

Auxiliary Contacts for KG Switches

Selection Data	Auxiliary contacts for:					
	KG10 KG10A KG10B	KG20 KG20B- KG32B	KG41- KG105C	KG125- KG162	KG210- KG317	

[< back to table of contents >](#)







Rated Insulation Voltage U_i	IEC/VDE UL/Canada	V V	690 300	500 600	690 600	690 600	690 600
Rated Thermal Current I_U/I_{th}	IEC/VDE/BS UL/Canada	A A	20 20	10 10	16 10	16 10	16 10
Rated Operational Current I_e							
AC-21A	Switching of resistive loads, including moderate overloads	IEC/VDE	A	20	10	16	16
AC-15	Switching of control devices, contactors, valves etc.	110 V-240 V	A	6	2,5	6	6
		380 V-440 V	A	4	1,5	3	3
		500 V	A	-	1	1,5	1,5
Pilot Duty	Heavy	UL/Canada		A300	A600	A600	A600
Ampere-Rating	Resistive or low inductive loads	UL/Canada	A	20 ¹	10	10	10
Short Circuit Protection							
	Max. fuse size	(gG-characteristic)	A	20	10	16	16
Max. Permissible Wire Gage - Use copper wire only							
	Single-core or stranded wire	mm ² AWG	2,5 12	1,5 14	2,5 12	2,5 12	2,5 12
	Flexible wire sleeving in accordance with DIN 46228	mm ²	2,5	1,5	2,5	2,5	2,5
	Flexible wire without sleeve	mm ² AWG	2,5 12	1,5 16	2,5 14	2,5 14	2,5 14

¹Max. 277 V.

Tightening torque of screws

Type	Tightening torque		Type	Tightening torque		Type	Tightening torque		Type	Tightening torque		Type	Tightening torque	
KG10	0,8 Nm	7 lb-in	KG32A	1,25 Nm	11 lb-in	KG80C	3 Nm	27 lb-in	KG127	14 Nm	125 lb-in	KG250	16 Nm	140 lb-in
KG10A	0,8 Nm	7 lb-in	KG32B	1,25 Nm	11 lb-in	KG100	3 Nm	27 lb-in	KG160	14 Nm	125 lb-in	KG251	16 Nm	140 lb-in
KG10B	0,8 Nm	7 lb-in	KG41	1,8 Nm	16 lb-in	KG100C	3 Nm	27 lb-in	KG161	14 Nm	125 lb-in	KG252	16 Nm	140 lb-in
KG20	1,25 Nm	11 lb-in	KG41B	1,8 Nm	16 lb-in	KG105	3 Nm	27 lb-in	KG162	14 Nm	125 lb-in	KG315	16 Nm	140 lb-in
KG20A	1,25 Nm	11 lb-in	KG64	1,8 Nm	16 lb-in	KG105C	3 Nm	27 lb-in	KG210	16 Nm	140 lb-in	KG316	16 Nm	140 lb-in
KG20B	1,25 Nm	11 lb-in	KG64B	1,8 Nm	16 lb-in	KG125	14 Nm	125 lb-in	KG211	16 Nm	140 lb-in	KG317	16 Nm	140 lb-in
KG32	1,25 Nm	11 lb-in	KG80	3 Nm	27 lb-in	KG126	14 Nm	125 lb-in	KG212	16 Nm	140 lb-in			

Country	Authority	Mark or Standard	KG10	KG20	KG32	KG41	KG64	KG80	KG100	KG105	KG125	KG160	KG210	KG250	KG315
			KG10A	KG20A	KG32A	KG41B	KG64B	KG80C	KG100C	KG105C	KG126	KG161	KG211	KG251	KG316
			KG10B	KG20B	KG32B						KG127	KG162	KG212	KG252	KG317

USA	Underwriters Laboratories	 ¹	●	●	●	●	●	●	●	●	●	●	●	●	●
Canada	Canadian Standards Association	 ²	●	●	●	●	●	●	●	●	●	●	●	●	●
International Electrical Commission (IEC) Recommendation		IEC 60204-1 ³ IEC 60947-3 ³	+	+	+	+	+	+	+	+	+	+	+	+	+
China	China Quality Certification Centre	 GB/T14048.3		●	●	●	●	●	●	●	●	●		●	●
Russia Belarus Kazakhstan	Eurasian Conformity		●	●	●	●	●	●	●	●	●	●	●	●	●
Russian Federation	Russian Maritime Register of Shipping			●	●	●	●	●	●	●					
Lloyds Register EMEA				●	●	●	●	●							

● Switch approved + Switch conforms to requirements

¹Devices provided with terminals suitable to connect unprepared wires are approved under the "Listing Program" (File No. E35541, Guide No. NLRV). Devices with bolt terminals are approved under the "Recognized Component Program" (File No. E35541, Guide No. NLRV2).

²Approved by use of "UL Certification Services for Canada" (File No. E35541, Guide No. NLRV7 or NLRV8 respectively).

³IEC does not operate an approval program.

⁴File No. 13002, Class No. 3211-05 resp. 4652-04.

KG switches are approved by UL and CSA as „disconnect switches for use in motor circuits“. Switches using ring type terminations (KG127, KG162, KG212, KG252, KG317) it is necessary to make connections to separate terminals.

The switches described in this catalog exceed the requirements of IEC 60947-3 and VDE 0660 part 107 and meet the standard on main switches and maintenance switches.

The new series offers a 4 pole switch body and symmetrically placed contacts. The adjustable length through shaft offers increased stability and permits interlocking devices to be added at the end of the switch. While reduced forces of the latching mechanism allows for easier operation.

The safety level of the KH- and KHR-series in numerous areas surpasses those of many international standard organizations: Positive contact movement during making and breaking operations. Higher air and creepage distances as well as for 800 V or 1000 V and finger-proof terminals according to EN 50274, VDE 0660 part 514 and DGUV V3. (protection IP 20 up to KHR40). Excellent AC-3 and AC-23A making and breaking capabilities providing

an additional safety advantage. For connecting with ring type terminals the KHR-series were designed. The terminal screw is held in place by a clamp allowing the ring type wire lug to be easily inserted in the terminal and tightened.

The KH- and KHR-series affords significant advantages during mounting and wiring. For ease of installation, switch terminations are on the same plane as the power conductors. Captive plus-minus screws and integrated screwdriver guides reduce wiring time. All base mounted switches feature a two hole mounting as well as "quick mount" designed for standard DIN rails according to EN 50022.

A large range of optional extras such as lateral mounted auxiliary contacts, ground terminals, auxiliary contacts (installed only at factory) also with contact systems for special programs, door clutches, shaft extensions and padlock devices enhance the flexibility of this proven line.

KH-series











KHR-series



[< back to table of contents >](#)

Nominal Ratings

Face plate Frame mm	Type	IEC 60947-3/VDE 0660 part 107			UL and Canada		
		Rated Values Thermal Current I_U/I_{th}	Utilization Category AC-23A 3 x 380 V-440 V	AC-3 AC-3 3 x 600 V	Ampere- Rating A	Standard Motor Load DOL-Rating 3 x 240 V HP	3 x 480 V HP
48 x 48 	KH16	16	7,5	5,5	16	2	5
	KH20	20	10	6,5	20	2	5
	KH25	25	12	7,5	25	3	7,5
64 x 64 	KHR20	20	10	6,5	20	2	5
	KH16B	16	7,5	5,5	16	2	5
	KH20B	20	10	6,5	20	2	5
	KH25B	25	12	7,5	25	3	7,5
64 x 64 	KHR20B	20	10	6,5	20	2	5
	KH32	32	16	11	30	5	10
	KH40	40	20	15	40	7,5	15
	KHR32	32	16	11	30	5	10
	KH63	63	30	22	60	20	40
	KH80	80	40	30	80	25	50
	KHR63	63	30	22	60	20	40
	KHR80	80	40	30	80	25	50

Mounting	Type	Code
 <p>Panel mounting</p> <p>Four hole panel mounting, Protection IP 66/67</p>	KH16-KHR80	E
 <p>Single hole mounting 22 mm</p> <p>With square face plate 48 x 48 mm, Protection IP 66/67/69k</p>	KH16-KHR25	FT2
 <p>With square face plate 64 x 64 mm, Protection IP 66/67/69k</p>	KH16-KHR80	FH3¹
 <p>Base mounting</p> <p>Screw/Snap-on base mounting for track EN 50022, Protection IP 40</p>	KH16-KHR80	VE
 <p>Screw/Snap-on base mounting for track EN 50022. Face plate for 45 mm knock-out, Protection IP 40</p>	KH16-KHR80	VE2

[< back to table of contents >](#)

¹For KH63-KHR80 use flexible wire in order to avoid excessive pressure on single hole mounting.

Plastic Enclosure Protection IP 66/67	Type	Code
---------------------------------------	------	------

	<p>The KL and CL enclosures are available in 3 sizes allowing for installation of 3, 4 and 6 pole KG switches. The KL-series is made of strong durable plastic and offers high UV-resistance. All KL- and KS-enclosures are flame resistant in accordance with UL94V-0. The CL-series is especially designed for applications in an aggressive environment, such as oil, chemical substances and grease. Each enclosure has 2 knock-outs on top and bottom for metric thread according to EN 50262. Included in each enclosure is a ground terminal. All enclosures can be supplied with a cover coupling for additional safety. Increased wiring space and mounting holes with slots are featured in this new line. These enclosures are also available for conduit entries for PG-thread. KS and CS enclosures have a compact size which allows for the installation of a 4 pole KH16 ON/OFF switch or a KH20/KHR20 ON/OFF switch. The design, options and mounting are the same as those of the KL and CL enclosures.</p>	<p>KH16-KHR80</p>	<p>KL. CL. KS. CS.</p>		
				Without cover interlock	0
				With cover interlock (The enclosure can only be opened at 9 o'clock position)	1
With cover interlock (The enclosure can only be opened at 12 o'clock position)	2				

[< back to table of contents >](#)

Switch Function and Configuration

Function	KH16 KH20 KH25	KHR20	KH16B KH20B KH25B	KHR20B	KH32 KH40	KHR32	KH63 KH80	KHR63 KHR80	Escutch. Plate	Code
----------	----------------------	-------	-------------------------	--------	--------------	-------	--------------	----------------	-------------------	------

Types of Mounting

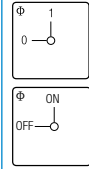
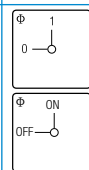
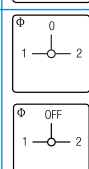
ON/OFF Switches 4 pole	E FT2 FH3 VE VE2 KS./KL.	E FT2 FH3 VE VE2 KS./KL.	E VE	E VE	E FH3 VE VE2 KL.	E FH3 VE VE2 KL.	E FH3 VE VE2 KL.	E FH3 VE VE2 KL.		K400
ON/OFF Switches 8 pole	E VE	E VE	E VE KL.	E VE KL.	E VE	E VE				K800
Double-throw Switches 4 pole	E VE	E VE	E VE KL.	E VE KL.	E VE VE2					K950

Connection Diagrams

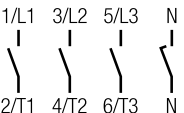
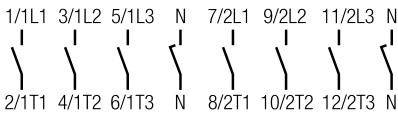
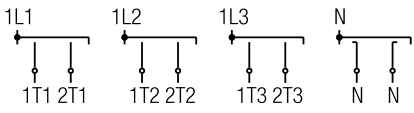
<p>ON/OFF Switches 4 pole</p> 	<p>ON/OFF Switches 8 pole</p> 	<p>Double-throw Switches 4 pole</p> 
--	--	--

Square and rectangular face plates are available for each size of switch. The face plate consists of a frame and a faceplate having the switch position which is then embossed with hot-foil backing. The face plate frame is an essential part of the switch and serves as a bearing surface for the handle. If the switch is to be mounted without an face plate we would recommend the handle bearing plate T100-04 which is available for switch types KH16B-KHR25B, KH32-KHR40 and KH63-KHR80. Face plates with special lettering are also available upon request.





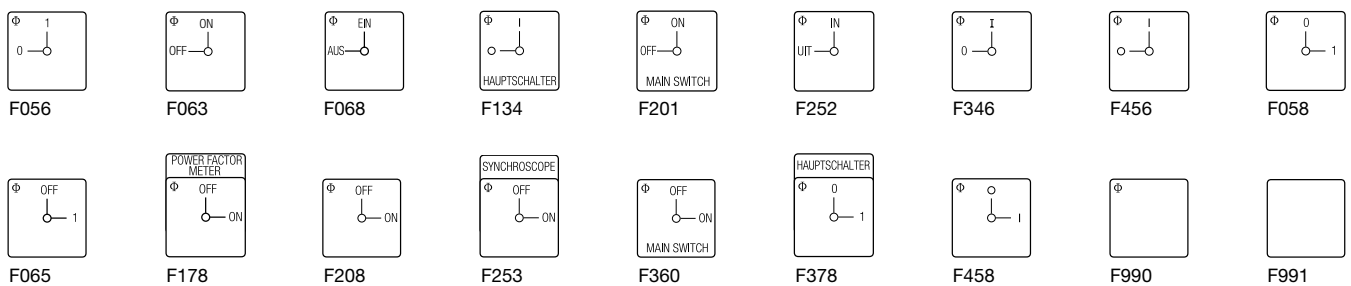



Standard Face plates



Handles

KH, KHR Switches

Type	Color	Code	KH16- KH25	KHR20	KH16B- KH25B	KHR20B	KH32- KHR32	KH63- KHR80
I-Handle 	black red	G251 G252	● ●	● ●	● ●	● ●	● ●	● ●
B-Handle 	black red	G521 G522	● ●	● ●	● ●	● ●	● ●	● ●
R-Handle 	black red	G001 G002	● ●	● ●	● ●	● ●	● ●	● ●
F-Handle 	black red	G221 G222	● ●	● ●	● ●	● ●	● ●	● ●
L-Handle 	black red	G501 G502	— —	— —	● ●	● ●	● ●	● ●
P-Handle  KH16-KHR25 KH16B-KHR80	black red	G211 G212	● ●	● ●	● ●	● ●	● ●	● ●
K-Handle 	black red	G411 G412	— —	— —	● ●	● ●	● ●	● ●



[< back to table of contents >](#)

Protective Covers and Auxiliary Contacts	Type	Code
--	------	------

Protective Covers

	For mounting E	KH32-KHR40	K1 M160/45-E
	For mounting VE		K1 M160/45-VE
	For mounting E	KH63-KHR80	K1 M160/44-E
	For mounting VE		K1 M160/44-VE

Cam-operated Auxiliary Contacts (mounting only at factory)

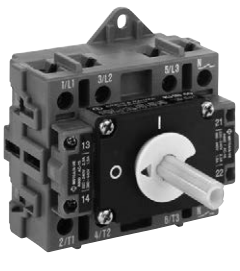
<p>For mounting E</p>  <p>KH16-KHR25B</p>	<p>Up to 4 cam-operated auxiliary contacts can be added to all switches (KH16-KHR25B max. 4/KH32-KHR80 max. 2).</p> <p>Select between a contact system with a rigid contact bridge for excellent AC-15 making and breaking capabilities or a contact system with gold contacts applicable for aggressive environments also.</p>	KH16-KHR80	M510A
 <p>KH32-KHR80</p>			
<p>For mounting VE</p> 			

[< back to table of contents >](#)

Auxiliary Contacts, Ground Terminal and Shaft Extensions	Type	Code
--	------	------

Lateral mounted Auxiliary Contacts

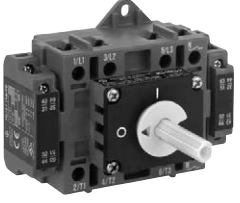

	Lateral mounted auxiliary contacts with 1 NO and 1 NC.				
	Standard contacts (nonoverlapping)	Terminal numbers			
		Attachment			
		left	right		
	For mounting E	(33-34, 41-42)	(53-54, 61-62)	KH16-	H010/A11-E
	For mounting VE	(31-32, 43-44)	(51-52, 63-64)	KHR25B	H010/A11-VE
	For mounting E	(33-34, 41-42)	(53-54, 61-62)	KH32-	H010/11A-E
	For mounting VE	(31-32, 43-44)	(51-52, 63-64)	KHR80	H010/11A-VE
Overlapping contacts					
For mounting E	(33-34, 41-42)	(53-54, 61-62)	KH16-	H010/B11-E	
For mounting VE	(31-32, 43-44)	(51-52, 63-64)	KHR25B	H010/B11-VE	
For mounting E	(33-34, 41-42)	(53-54, 61-62)	KH32-	H010/11B-E	
For mounting VE	(31-32, 43-44)	(51-52, 63-64)	KHR80	H010/11B-VE	

Ground Terminal





		KH16- KHR80	H052
--	--	----------------	-------------

[< back to table of contents >](#)

Shaft Extensions

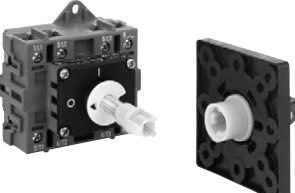
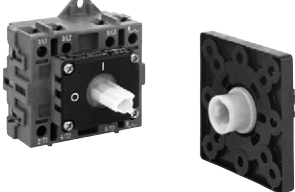

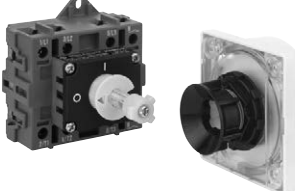
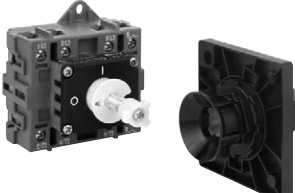

	With asymmetric profile	KH16- KHR80	L100¹
	Shaft length not adjustable		
	Shaft with adjustable length with set screw with shear ring		M004D³ M004³
	With square profile		L100A¹
	Shaft length not adjustable		
	Shaft with adjustable length with set screw		M004E²
Ordering data:		Free shaft length or dimension from mounting surface to cover.	

¹Available for switch types from KH16B. ²Available for switch types from KH32. ³Not available for KH..B.

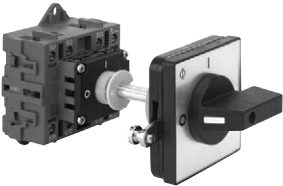

Simplified Door Clutch	Type	Code	
 <p>The simplified door clutches are utilized primarily when the switch is mounted to the bottom of the enclosure and the handle and face plate are mounted on the cover.</p> <p>With shaft extension Front protection IP 40</p>	KH16-KHR80	M290/A3	
 <p>With profile extension parts Front protection IP 65</p>			M290/A1.EF ²
 <p>With padlock device, single hole mounting 22 mm, protection IP 66. An additional aluminum shaft extension is required.</p>			V840E ¹
 <p>The cover disc is available in black, yellow and electro-gray. The handle may be supplied in black, red and electro-gray.</p>			V840G ¹ V840F ¹
 <p>Operation of the locking bar from the front. Available in black, red and electro-gray.</p>			V845
 <p>Centering device for simplified door clutches with single hole mounting and shaft extension Misalignment between the shaft and mounting are compensated in all 4 directions.</p>			M600 ¹
<p>Ordering data:</p>			

[< back to table of contents >](#)

¹Available for switch types from KH16B. ²Available for switch types from KH32.



Door Clutches	Type	Code																								
 <p>The M280 door clutch has an adjustable shaft and can be supplied with an interlock device.</p> <p>The following interlock programs are available:</p> <p>A = Without interlock by door clutch B = With interlock by door clutch C = With interlock by rods D = With interlock by door clutch and rods</p> <p>With protected profile</p> <p>shaft fixation with set screw Front protection IP 40 Front protection IP 66/67</p> <p>shaft fixation with shear ring Front protection IP 40 Front protection IP 66/67</p>  <p>Handle lockable with padlocks Protection IP 66 Selection of escutch. plate and handle color required:</p> <table border="1" data-bbox="528 1093 1161 1323"> <thead> <tr> <th>Escutcheon Plate</th> <th>Frame Plate</th> <th>Handle</th> <th>Lock Bar</th> </tr> </thead> <tbody> <tr> <td>A = brushed alu</td> <td>black</td> <td>black</td> <td>red</td> </tr> <tr> <td>B = brushed alu</td> <td>black</td> <td>red</td> <td>yellow</td> </tr> <tr> <td>C = brushed black</td> <td>black</td> <td>black</td> <td>red</td> </tr> <tr> <td>D = brushed black</td> <td>black</td> <td>red</td> <td>yellow</td> </tr> <tr> <td>E = yellow</td> <td>black</td> <td>red</td> <td>yellow</td> </tr> </tbody> </table> <p>The M700 is a padlock door clutch and a mechanical interlocking safety device. Using the device the electrical panel may be opened only when the switch is in the OFF position and no padlock is fitted. Note: Only in the ON position can knowledgeable personnel using a simple tool to defeat the interlock. The M700's flexibility allows for successful installation with as much as + or - 5 mm of misalignment between the shaft and door.</p>  <p>Standard handle and standard face plate Protection IP 66 The M700's flexibility allows for successful installation with as much as + or - 5 mm of misalignment between the shaft and door.</p>  <p>Unlock insert for the M700 to open the door in ON position. (After the locking has been made inactive, it is necessary to take effective precautions against an opening of the door by unauthorized persons.)</p>	Escutcheon Plate	Frame Plate	Handle	Lock Bar	A = brushed alu	black	black	red	B = brushed alu	black	red	yellow	C = brushed black	black	black	red	D = brushed black	black	red	yellow	E = yellow	black	red	yellow	<p>KH16-KHR80</p> <p>KH16B-KHR80</p>	<p>M280E M280E/.EF</p> <p>M280D M280D/.EF</p> <p>M700/.</p> <p>M701</p> <p>S1D M700 29</p>
Escutcheon Plate	Frame Plate	Handle	Lock Bar																							
A = brushed alu	black	black	red																							
B = brushed alu	black	red	yellow																							
C = brushed black	black	black	red																							
D = brushed black	black	red	yellow																							
E = yellow	black	red	yellow																							
<p>Ordering data:</p>	<p>Dimension from face of the switch to the cover or dimension from mounting surface to cover, the interlock program and the color selection.</p>																									

[< back to table of contents >](#)

Padlock Devices	Type	Code
 <p>The padlock device is an integral part of the switch.</p> <p>For 2 padlocks Operation of the locking bar from the bottom. Available in black, red and electro-gray.</p>	KH16-KHR80	V840A
 <p>For 4 padlocks Operation of the locking bar from the front. Available in black, red and electro-gray.</p>		V845
<p>Padlock device with integrated F- or B-handle. The cover disc is available in black, yellow and electro-gray. The handle may be supplied in black, red and electro-gray.</p>		
 <p>For 2 padlocks with F-handle</p>	KH16-KHR25	V840D
<p>For 3 padlocks with F-handle with B-handle</p> <p>For 4 padlocks with F-handle with B-handle</p> <p>Padlock devices with simplified door clutch and single hole mounting see page 32.</p>		V840G V840G/B
<p>Ordering data:</p>		V840F/F V840F/B
<p>For V840 and V845 color selection required.</p>		

[< back to table of contents >](#)

Country	Authority	Mark or Standard	KH16 KH16B	KH20 KH20B	KHR20 KHR20B	KH25 KH25B	KH32 KHR32	KH40	KH63 KHR63	KH80 KHR80
---------	-----------	------------------	---------------	---------------	-----------------	---------------	---------------	------	---------------	---------------

USA	Underwriters Laboratories			●			●	●	●	●
Canada	Canadian Standards Association		●	●		●	●	●	●	●
International Electrical Commission (IEC) Recommendation		IEC 60204-1 ¹ IEC 60947-3 ¹	+	+	+	+	+	+	+	+
Russia Belarus Kazakhstan	Eurasian Conformity		●	●		●	●	●	●	●

- Switch approved
- + Switch conforms to requirements

¹IEC does not operate an approval program.

The switches of the KH/KHR-series are approved by UL and CSA as „disconnect switches for use in motor circuits“. UL approved terminals are required when making connection to switches having ring type terminations (KHR).

Selection Data	KH16	KH20	KHR20	KHR25	KH32		KH63	KH80
	KH16B	KH20B	KHR20B	KHR25B	KHR32	KH40	KHR63	KHR80

Rated Insulation Voltage U_i	IEC/EN/VDE ¹	V	800 ²	800 ²	800 ²	800 ²	800 ²	800 ²	1000 ²	1000 ²		
	UL/Canada	V	600	600	600	600	600	600	600	600		
Rated Impulse Withstand Voltage U_{imp} ¹		kV	6	6	6	6	6	6	8	8		
Rated Thermal Current	IEC/EN/VDE	$I_{u, open} = I_{th}$	A	16	20	20	20	32	40	63	80	
		$I_{the, enclosed}$	A	16	20	20	20	32	40	63	80	
	UL/Canada		A	16	20	20	20	30	40	60	80	
Rated Operational Current I_e												
AC-21A	Switching of resistive loads, including moderate overloads	IEC/EN/VDE	A	16	20	20	20	32	40	63	80	
AC-22A	Switching of combined resistive or low inductive loads, including moderate overloads	IEC/EN/VDE	A	16	20	20	20	32	40	63	80	
Ampere-Rating	Resistive or low inductive loads	UL/Canada	A	16	20	20	20	30	40	60	80	
Rated Utilization Category			IEC/EN/VDE									
AC-3	Direct-on-line starting	3 phase 3 pole	220 V-240 V 380 V-440 V 500 V 660 V-690 V	kW	3	3,5	3,5	4	5,5	7,5	11	15
				kW	5,5	6,5	6,5	7,5	11	15	22	30
				kW	5,5	6,5	6,5	7,5	11	15	30	37
				kW	5,5	6,5	6,5	7,5	11	15	18,5	22
AC-23A	Frequent switching of motors or other high inductive loads	3 phase 3 pole	220 V-240 V 380 V-440 V 500 V 660 V-690 V	kW	4,5	5,5	5,5	5,5	9	11	18,5	23
				kW	7,5	10	10	10	16	20	30	40
				kW	10	12	12	13	20	25	40	55
				kW	13	15	15	17	22	25	30	37
DOL-Rating	Standard motor load (similar AC-3)	UL/Canada 3 phase 3 pole	110 V-120 V 220 V-240 V 440 V-480 V 550 V-600 V	HP	1	1	1	1,5	2	3	7,5	10
				HP	2	2	2	3	5	7,5	20	25
				HP	5	5	5	7,5	10	15	30	40
				HP	5	5	5	7,5	10	15	40	50
Power loss per contact at I_u			W	0,2	0,3	0,3	0,3	0,4	0,6	1,5	2,7	
Resistance to vibration ³				C	C	C	C	C	C	C	C	
Resistance to shock ³				C	C	C	C	C	C	C	C	
Short Circuit Protection												
Max. fuse size (gG-characteristic)			A	25	35	35	35	35	50	80	100	
Rated short-time withstand current (1s-current)			A	400	450	450	500	850	950	1200	1600	
Max. Permissible Wire Gage - Use copper wire only												
KH	For box terminal	Single-core or stranded wire	mm ²	6	6	-	-	10	10	35	35	
			AWG	10	10	-	-	8	8	2	2	
		Flexible wire sleeving in accordance with DIN46228	mm ²	4	4	-	-	6	6	25	25	
KHR	Connection with insulated ring and fork type terminals	Internal diameter \geq External diameter \leq	mm	-	-	3,2	3,2	3,7	-	5,2	5,2	
			mm	-	-	7,4	7,4	8,8	-	12,7	12,7	
Ambient Temperature ⁴				-5 °C (-25 °C auf Anfrage)								
Ambient Temperature ⁴				50 °C über 24 Stunden mit Spitzen bis 55 °C								
				35 °C über 24 Stunden mit Spitzen bis 40 °C								

[< back to table of contents >](#)

¹Valid for lines with grounded common neutral termination, overvoltage category III, pollution degree 3. Values for other supply systems on request.
²Suitable for no load switching applications (AC-20A) above 690 V. ³C: on request. ⁴Storage temperature: -40 °C to 85 °C (in case of temperature below -5 °C no shock load permissible).

Selection Data	Auxiliary contacts for: KH16-KHR80
-----------------------	---------------------------------------

Rated Insulation Voltage U_i		IEC/EN/VE	V	440	
		UL/Canada	V	300	
Rated Thermal Current I_u/I_{th}		IEC/EN/VE	A	10	
		UL/Canada	A	10	
Rated Operational Current I_o					
AC-21A	Switching of resistive loads, including moderate overloads	IEC/EN/VE	A	10	
AC-15	Switching of control devices, contactors, valves etc.		110 V-240 V	A	2,5
			380 V-440 V	A	1,5
Pilot Duty	Heavy	UL/Canada		A300	
Ampere-Rating	Resistive or low inductive loads	UL/Canada	A	10	
Short Circuit Protection					
	Max. fuse size	(gG-characteristic)	A	10	
Max. Permissible Wire Gage - Use copper wire only					
	Single-core or stranded wire	mm ²		1,5 (2,5) ¹	
		AWG		14 (12) ¹	
	Flexible wire sleeving in accordance with DIN46228	mm ²		1,5 (2,5) ¹	
	Flexible wire without sleeve	mm ²		1,5 (2,5) ¹	
		AWG		16 (14) ¹	

[< back to table of contents >](#)

¹The values in brackets are valid for switches KH32-KHR80 E mounting.

Tightening torque of screws

Type	Tightening torque		Type	Tightening torque		Type	Tightening torque	
KH16	1,2 Nm	10 lb-in	KH25B	1,2 Nm	10 lb-in	KHR20	1,2 Nm	10 lb-in
KH16B	1,2 Nm	10 lb-in	KH32	1,2 Nm	10 lb-in	KHR20B	1,2 Nm	10 lb-in
KH20	1,2 Nm	10 lb-in	KH40	1,2 Nm	10 lb-in	KHR32	1,2 Nm	10 lb-in
KH20B	1,2 Nm	10 lb-in	KH63	3 Nm	27 lb-in	KHR63	2,2 Nm	20 lb-in
KH25	1,2 Nm	10 lb-in	KH80	3 Nm	27 lb-in	KHR80	2,2 Nm	20 lb-in

Mounting
(Additional length for auxiliary contacts see page 42)

ON/OFF Switches 3 and 4 pole

E	A	B	C	D1	D2	D3	E	F	G	G1 ¹	H	L	
	KG10A	48	36	4	11-15	5	-	48	48	-	50	48,2	
	KG10B	64	48	4	11-15	5	-	64	48	-	50	57,2	
	KG20, KG32	30	-	4	8-11	-	3,2	20	-	42	13,5	50,8	
	KG20A, KG32A	48	36	4	10-15	5	-	-	48	42	13,5	54	
	KG20B, KG32B	64	48	4	10-15	5	-	-	64	42	13,5	54	
	KG41, KG64	48	36	4	10-15	5	-	-	48	42	13,5	54	
	KG41B, KG64B	64	48	4	10-15	5	-	-	64	42	13,5	54	
	KG80, KG100, KG105	64	48	4	10-15	5	-	-	70	70	22	80	
	KG80C, KG100C, KG105C	88	68	4	10-15	6	-	-	88	70	22	80	
		3,46	2,68	.16	.39-.59	.24	-	-	3,46	2,76	.87	3,15	2,78

A	B	C	D1	D2	G	G1 ¹	H	L	N	R	S	S1
88	68	5,5	13-17	6	112	38	108	96	-	-	-	-
3,46	2,68	.22	.51-.67	.24	4,41	1,50	4,25	3,78	-	-	-	-
88	68	5,5	13-17	6	112	38	110	96	45	20	36	38
3,46	2,68	.22	.51-.67	.24	4,41	1,50	4,33	3,78	1,77	.79	1,36	1,50
88	68	5,5	13-17	6	112	38	109	96	45	20	36	38
3,46	2,68	.22	.51-.67	.24	4,41	1,50	4,29	3,78	1,77	.79	1,36	1,50
88	68	5,5	13-17	6	145	52,5	126	103	-	-	-	-
3,46	2,68	.22	.51-.67	.24	5,71	2,07	4,96	4,05	-	-	-	-
88	68	5,5	13-17	6	145	52,5	126	103	50	26	44	52,5
3,46	2,68	.22	.51-.67	.24	5,71	2,07	4,96	4,05	1,97	1,02	1,73	2,07
88	68	5,5	13-17	6	145	52,5	126	103	50	26	52	52,5
3,46	2,68	.22	.51-.67	.24	5,71	2,07	4,96	4,05	1,97	1,02	2,05	2,07

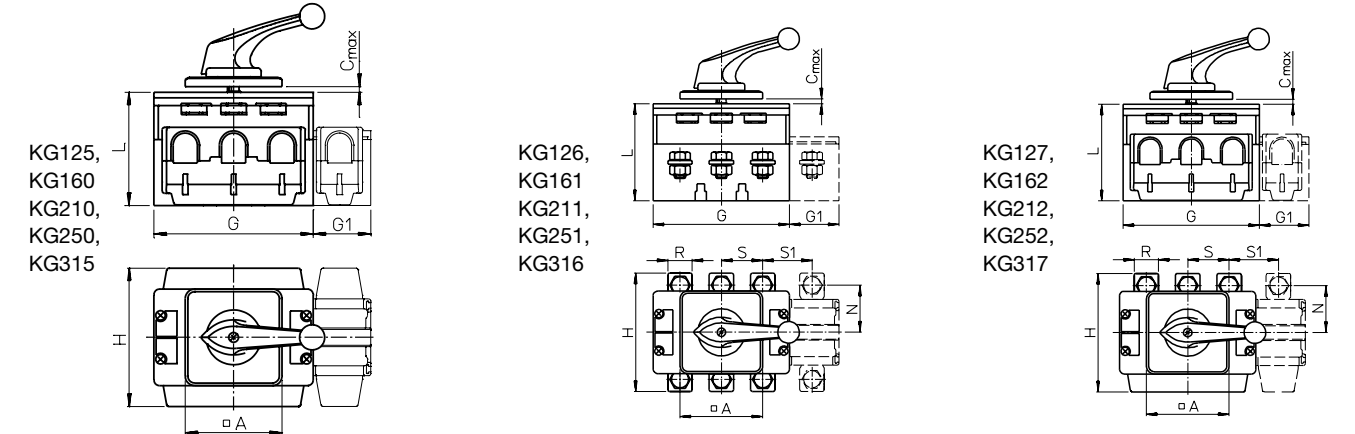

FT1, FT2

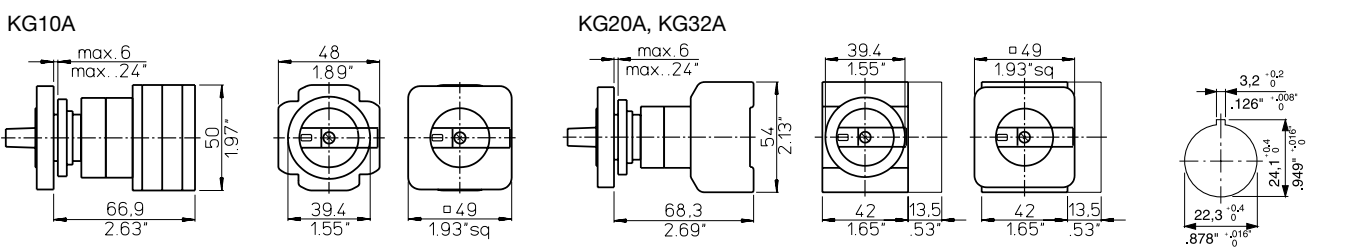

¹For ON/OFF switches 4 pole.

[< back to table of contents >](#)

Mounting

(Additional length for auxiliary contacts see page 42)

ON/OFF Switches 3 and 4 pole

VE, VE1

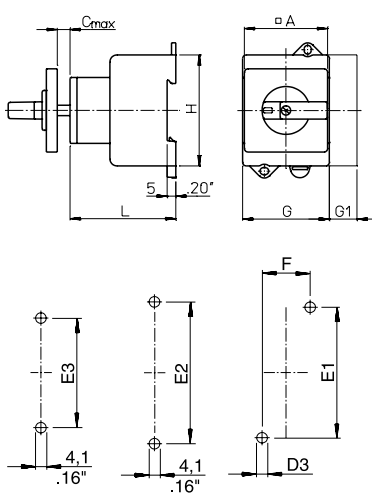

	A	B	C	D1	D2	D3	E1 ¹	E2 ¹	E3 ¹	F	G	G1 ²	H	L	M
KG10A	48	36	12	8-15	5	4,2	60	65	50	22	48	-	50	49,5	-
KG10B	64	48	29	10-15	5	4,2	60	65	50	22	48	-	50	56,5	-
KG20, KG32	30	-	12	8-11	3,2	4,1	60	-	-	22	42	13,5	54	50	20
KG20A, KG32A	48	36	12	8-15	5	4,1	60	-	-	22	42	13,5	54	50	-
KG20B, KG32B	64	48	13,5	10-15	5	4,1	60	-	-	22	42	13,5	54	50	-
KG41, KG64	48	36	12	10-15	5	4,1	70	-	-	25	50	16	64	61	-
KG41B, KG64B	64	48	13,5	10-15	5	4,1	70	-	-	25	50	16	64	61	-
KG80, KG100, KG105	64	48	13,5	10-15	5	5,2	90	-	-	25	70	22	80	68	-
KG80C, KG100C, KG105C	88	68	13,5	10-15	6	5,2	90	-	-	25	70	22	80	68	-

	A	B	C	D1	D2	D3	G	G1 ²	H	L ³	N	P	Q1	Q2	R	S	S1
KG125, KG160	88	68	16	13-17	6	6,4	112	38	108	91	-	36	59-61	59-61	-	-	-
KG126, KG161	88	68	16	13-17	6	6,4	112	38	110	91	45	36	38-40	38-40	20	36	38
KG127, KG162	88	68	16	13-17	6	6,4	112	38	109	91	45	36	38-40	59-61	20	36	38
KG210, KG250, KG315	88	68	16	13-17	6	6,4	145	52,5	126	98	-	44	70-72	70-72	-	-	-
KG211, KG251	88	68	16	13-17	6	6,4	145	52,5	126	98	50	44	40-42	40-42	26	44	52,5
KG212, KG252	88	68	16	13-17	6	6,4	145	52,5	126	98	50	44	40-42	70-72	26	44	52,5
KG316	88	68	16	13-17	6	6,4	145	52,5	126	98	50	44	40-42	40-42	26	52	52,5
KG317	88	68	16	13-17	6	6,4	145	52,5	126	98	50	44	40-42	70-72	26	52	52,5

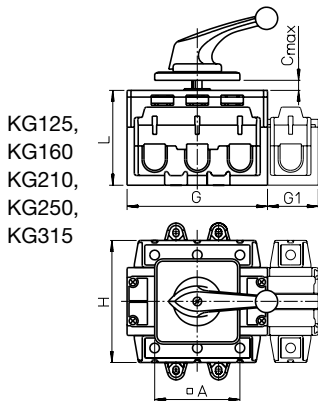
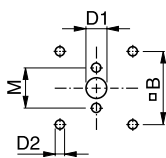

KG126, KG161, KG211, KG251, KG316

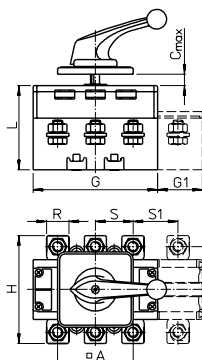

KG127, KG162, KG212, KG252, KG317

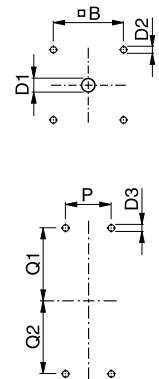
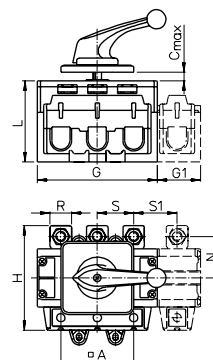

VE2

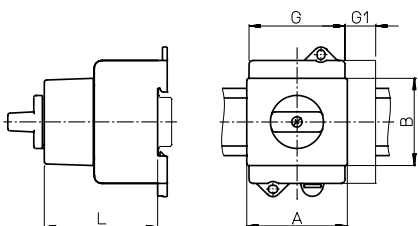

	A	B	G	G1 ²	L
KG20A, KG32A	43,7	45,4	42	13,5	56,5
KG41, KG64	52,4	45,4	50	16	56,5
KG80, KG100, KG105	70	45	70	22	65
KG125-KG162	112	45	112	38	98

VE21

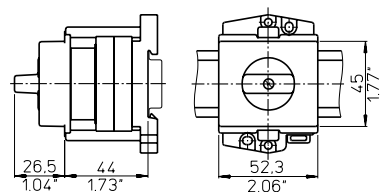

< back to table of contents >

¹Switches KG10A and KG10B allow use of E1, E2 or E3. ²For ON/OFF switches 4 pole. ³KG125-KG162 additional length for mounting VE1 = 7,5 mm/30 inch.

Mounting

(Additional length for auxiliary contacts see page 42)

ON/OFF Switches 6 and 8 pole and Double-throw Switches

E	A	B	C	D1	D2	F	G	G1 ¹	H	L _{6p.}	L _{8p.}	
	KG10A	48	36	4	11-15	5	48	48	-	50	57,7	67,2
	KG10B	64	48	4	11-15	5	64	48	-	50	66,7	76,2
	KG20A, KG32A	48	36	4	10-15	5	48	84	13,5	54	61,3	-
	KG20B, KG32B	64	48	4	10-15	5	64	84	13,5	54	61,3	-
	KG41B, KG64B	64	48	4	10-15	5	64	100	16	64	66,5	-
	KG80, KG100, KG105	64	48	4	10-15	5	70	140	22	80	81,8	-
	KG80C, KG100C, KG105C	88	68	4	10-15	6	88	140	22	80	81,8	-
		3.46	2.68	.16	.39-.59	.24	3.46	5.51	.87	3.15	3.22	-
		2.52	1.89	.16	.39-.59	.20	2.52	3.31	.53	2.13	2.41	-
		1.89	1.42	.16	.39-.59	.20	1.89	3.30	.53	2.13	2.41	-

KG125, KG160

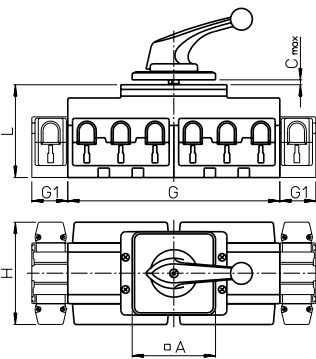

A	B	C	D1	D2	G	G1 ¹	H	L	N	R	S	S1	S2
88	68	5,5	13-17	6	224	38	108	98	-	-	-	-	-
3.46	2.68	.22	.51-.67	.24	8.82	1.50	4.25	3.86	-	-	-	-	-
88	68	5,5	13-17	6	224	38	110	98	45	20	36	38	20
3.46	2.68	.22	.51-.67	.24	8.82	1.50	4.33	3.86	1.77	.79	1.42	1.50	.79
88	68	5,5	13-17	6	224	38	109	98	45	20	36	38	20
3.46	2.68	.22	.51-.67	.24	8.82	1.50	4.29	3.86	1.77	.79	1.42	1.50	.79

KG126, KG161

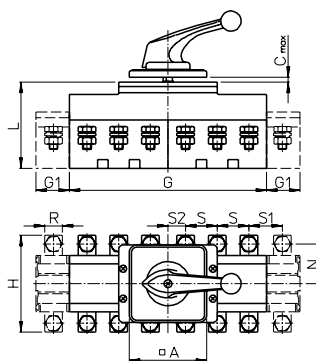

KG127, KG162

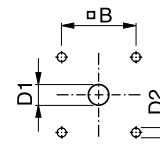
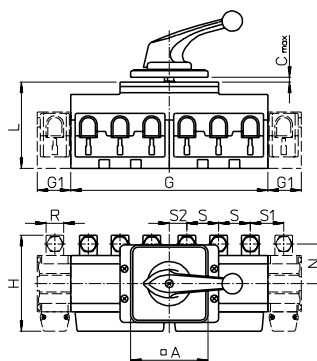

FT1, FT2

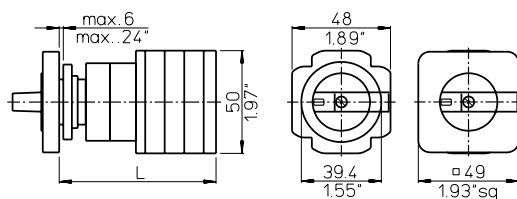

	L _{6p.}	L _{8p.}
KG10A	76,4	85,9
	3.01	3.38

¹For ON/OFF switches 8 pole and double-throw switches 4 pole.

Mounting

(Additional length for auxiliary contacts see page 42)

ON/OFF Switches 6 and 8 pole and Double-throw Switches

VE, VE1

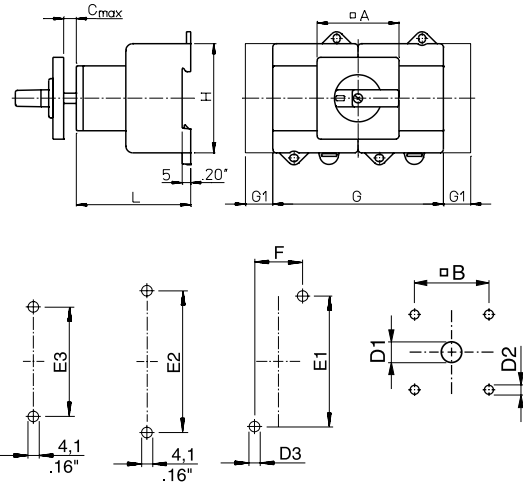

ON/OFF switches 6 pole
double-throw switches 3 pole

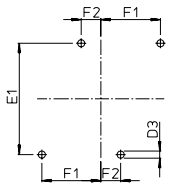

double-throw switches 4 pole

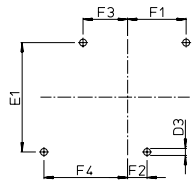

	A	B	C	D1	D2	D3	E1 ¹	E2 ¹	E3 ¹	F	F1
KG10A	48	36	12	8-15	5	4,2	60	65	50	22	-
KG10B	64	48	29	10-15	5	4,2	60	65	50	22	-
KG20A, KG32A	48	36	12	8-15	5	4,1	60	-	-	-	32
KG20B, KG32B	64	48	13,5	10-15	5	4,1	60	-	-	-	32
KG41B, KG64B	64	48	13,5	10-15	5	4,1	70	-	-	-	37,5
KG80, KG100	64	48	13,5	10-15	5	5,2	90	-	-	-	47,5
KG105	2,52	1,89	.53	.39-.59	.20	.16	2,36	-	-	-	1,87
KG80C, KG100C	88	68	13,5	10-15	6	5,2	90	-	-	-	47,5
KG105C	3,46	2,68	.53	.39-.59	.24	.21	3,54	-	-	-	1,87

	F2	F3	F4	G	G1 ²	H	L6p.	L8p.
KG10A	-	-	-	48	-	50	58,7	68,2
KG10B	-	-	-	48	-	50	65,7	75,2
KG20A, KG32A	10	23,5	45,5	84	13,5	54	57,5	-
KG20B, KG32B	10	23,5	45,5	84	13,5	54	57,5	-
KG41B, KG64B	12,5	28,5	53,5	100	16	64	67	-
KG80, KG100	22,5	44,5	69,5	140	22	80	79,2	-
KG105	.89	1,75	2,74	5,51	.87	3,15	3,12	-
KG80C, KG100C	22,5	44,5	69,5	140	22	80	79,2	-
KG105C	.89	1,75	2,74	5,51	.87	3,15	3,12	-

	A	B	C	D1	D2	D3	G	G1 ²	H	L ³	N	P	Q1	Q2	R	S	S1	S2
KG125, KG160	88	68	16	13-17	6	6,4	224	38	108	93	-	76	59-61	59-61	-	-	-	-
KG126, KG161	88	68	16	13-17	6	6,4	224	38	110	93	45	76	38-40	38-40	20	36	38	20
KG127, KG162	88	68	16	13-17	6	6,4	224	38	109	93	45	76	38-40	59-61	20	36	38	20

KG125, KG160

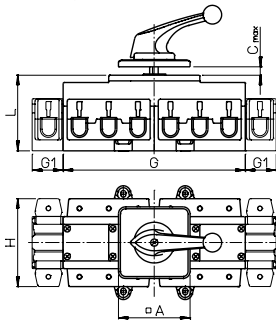

KG126, KG161

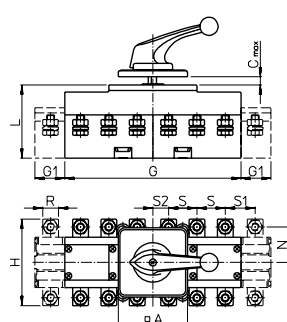

KG127, KG162

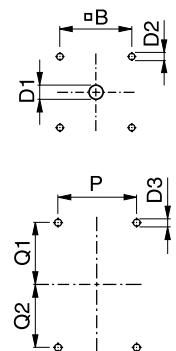
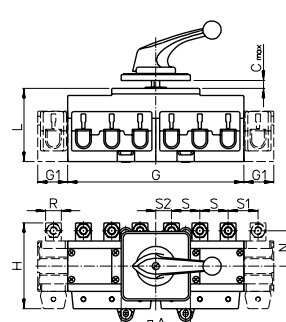

VE2

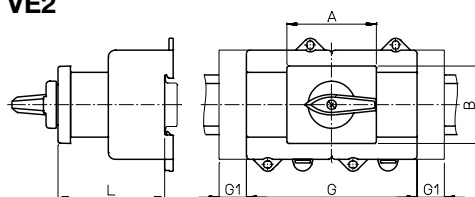

KG20A, KG32A	43,7	45,4	84	13,5	64
KG41B, KG64B	105,4	45,4	100	16	62,5
KG80, KG100, KG105	70	45	140	22	76,2

	A	B	G	G1 ²	L
KG20A, KG32A	43,7	45,4	84	13,5	64
KG41B, KG64B	105,4	45,4	100	16	62,5
KG80, KG100, KG105	70	45	140	22	76,2

VE21

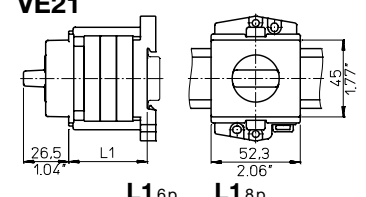

KG10A	46/1.81	54/2.13
-------	---------	---------

¹Switches KG10A and KG10B allow use of E1, E2 or E3. ²For ON/OFF switches 8 pole and double-throw switches 4 pole. ³Additional length for mounting VE1 = 7,5 mm/.30 inch.

Plastic Enclosures and Optional Extras

Switches in Plastic Enclosure

KL..., CL..., KS5., CS5.

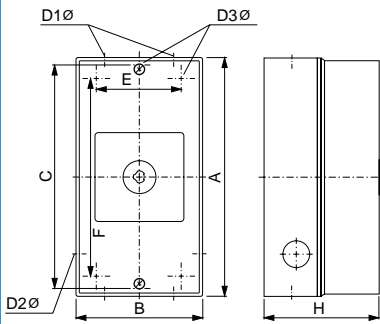

	3 and 4 pole	6 pole, Double-throw	8 pole, Double-throw	A	B	C	D1	D2	D3	E	F	H
KG10 ¹	x	x	x	120	85	110	2x20/25 ²	20	4,2	-	-	80
KG20 ¹	x			120	85	110	2x.79/.98 ²	.79	.17	-	-	3.15
KG20, KG32	x			160	85	150	2x20/25	20	4,2	-	-	80
KG20B, KG32B	x			6.30	3.35	5.91	2x.79/.98	.79	.17	-	-	3.15
				190	100	178	2x25	25	5,6	-	-	91
				7.48	3.94	7.01	2x.98	.98	.22	-	-	3.58
			x	250	145	-	2x25/40	25	6,5	124	229	107
				9.84	5.71	-	2x.98/1.57	.98	.26	4.88	9.02	4.21
KG41, KG64	x			190	100	178	2x25	25	5,6	-	-	91
				7.48	3.94	7.01	2x.98	.98	.22	-	-	3.58
KG41B, KG64B	x		x	250	145	-	2x25/40	25	6,5	124	229	107
				9.84	5.71	-	2x.98/1.57	.98	.26	4.88	9.02	4.21
KG80, KG100, KG105	x			250	145	-	2x25/40	25	6,5	124	229	107
				9.84	5.71	-	2x.98/1.57	.98	.26	4.88	9.02	4.21

PFA-PFF5

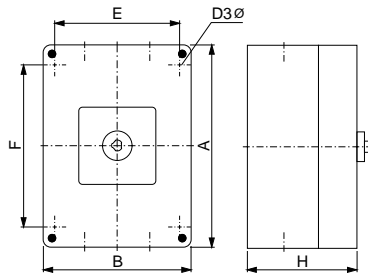

	3 and 4 pole	6 and 8 pole, Double-throw	A	B	E	F	H	D3
KG20A, KG32A, KG41, KG64	x		135	92	78	110	91	4,4
			5.31	3.62	3.07	4.33	3.58	.17
KG20B, KG32B, KG41B, KG64B		x	180	140	128	150	98	4,5
			7.09	5.51	5.04	5.91	3.86	.18
KG80, KG100	x		180	140	128	150	98	4,5
			7.09	5.51	5.04	5.91	3.86	.18

Cam/rack-operated Auxiliary Contacts

E	VE	Mounting	M	
			allows use of 1 or 2 contacts	allows use of 3 or 4 contacts
KG20-KG105C	KG20-KG105C	E/VE	9	25,8
			.35	1.02
		E	10	30
			.39	1.18
			10	30
KG125-KG317	KG125-KG317	VE	10	30
			1.86	1.18
		VE2	20	40
			1.86	1.57
			.79	
		Mounting	M	
		E	21	.83

Lateral mounted Auxiliary Contacts

	M
KG20, KG20A, KG20B, KG32, KG32A, KG32B	10
	.39
KG41, KG41B, KG64, KG64B	11
	.43
KG80, KG80C, KG100, KG100C, KG105, KG105C	11
	.43
KG125-KG317	14
	.55

¹KS5., CS5.

Optional Extras

Ground and Neutral Terminal, Additional Main Contact

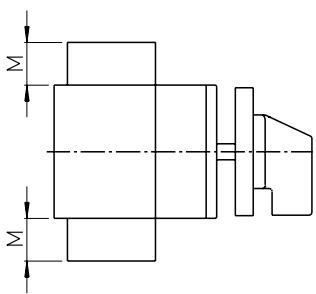

	M
KG20, KG20A, KG20B, KG32, KG32A, KG32B	13,5 .53
KG41, KG41B, KG64, KG64B	16 .63
KG80, KG80C, KG100, KG100C, KG105, KG105C	22 .87
KG125, KG126, KG127, KG160, KG161, KG162	38 1.50
KG210, KG211, KG212, KG250, KG251, KG252, KG315, KG316, KG317	52,5 2.07

Protective Cover

< back to table of contents >

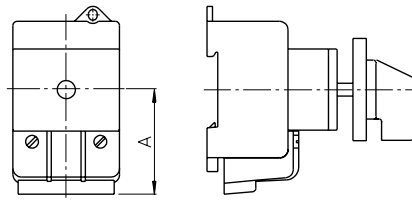

	A
KG10A, KG10B	30 1.18
KG20, KG20A, KG20B, KG32, KG32A, KG32B	47 1.85
KG41, KG41B, KG64, KG64B	49 1.93
KG80, KG80C, KG100, KG100C, KG105, KG105C	66 2.60

With box terminal

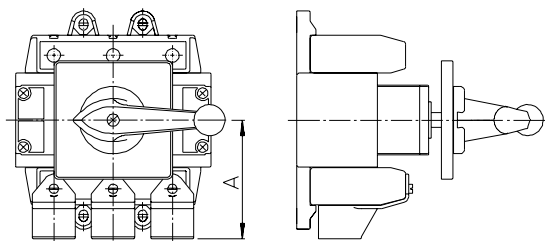

	A
KG125-KG162 with box terminal	76,2 3.00
KG125-KG162 with bolt terminal	112 4.41
KG210-KG317 with box terminal	88 3.46
KG210-KG317 with bolt terminal	160 6.30

With bolt terminal

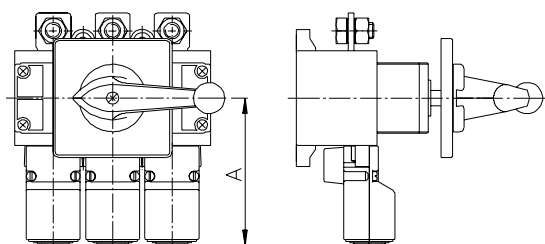

Optional Extras

Shaft Extension

L100, L100A

L1 = Free shaft length

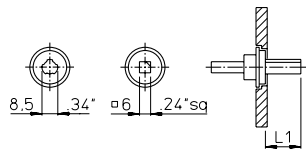

	Mounting	L1								
		L1	L1	L1	L1	L1	L1	L1	L1	L1
KG10B	E	19	23	27	32	37	42	47	52	57
	VE	.75	.91	1.06	1.26	1.46	1.65	1.85	2.05	2.24
KG20B, KG32B	E	11,5	16,5	20,5	24,5	29,5	34,5	39,5	44,5	49,5
	VE	.45	.65	.81	.96	1.16	1.36	1.56	1.75	1.95
KG41B, KG64B	E	13,5	17,5	21,5	26,5	31,5	36,5	41,5	46,5	51,5
	VE	.53	.69	.85	1.04	1.24	1.44	1.63	1.83	2.03
KG80, KG80C	E	13,5	17,5	21,5	26,5	31,5	36,5	41,5	46,5	51,5
	VE	.53	.69	.85	1.04	1.24	1.44	1.63	1.83	2.03
KG100, KG100C	E	16,5	20,5	24,5	29,5	34,5	39,5	44,5	49,5	54,5
	VE	.65	.81	.96	1.16	1.36	1.56	1.75	1.95	2.15
KG105, KG105C	E	16,5	20,5	24,5	29,5	34,5	39,5	44,5	49,5	54,5
	VE	.65	.81	.96	1.16	1.36	1.56	1.75	1.95	2.15

	Mounting	L1								
		L1	L1	L1	L1	L1	L1	L1	L1	L1
KG10B	E	62	67	72	77	82	87	92	97	102
	VE	2.44	2.64	2.83	3.03	3.23	3.43	3.62	3.82	4.02
KG20B, KG32B	E	61	66	71	76	81	86	91	96	101
	VE	2.40	2.60	2.80	2.99	3.19	3.39	3.58	3.78	3.98
KG41B, KG64B	E	54,5	59,5	64,5	69,5	74,5	79,5	84,5	89,5	94,5
	VE	2.15	2.34	2.54	2.74	2.93	3.13	3.33	3.52	3.72
KG80, KG80C	E	61	66	71	77	81	86	91	96	101
	VE	2.40	2.60	2.80	3.03	3.19	3.39	3.58	3.78	3.98
KG100, KG100C	E	56,5	61,5	66,5	71,5	76,5	81,5	86,5	91,5	96,5
	VE	2.22	2.42	2.62	2.81	3.01	3.21	3.41	3.60	3.80
KG105, KG105C	E	58,8	63,8	68,8	73,8	78,8	83,8	88,8	93,8	98,8
	VE	2.31	2.51	2.71	2.91	3.10	3.30	3.50	3.69	3.89
KG125, KG126	E	56,5	61,5	66,5	71,5	76,5	81,5	86,5	91,5	96,5
	VE	2.22	2.42	2.62	2.81	3.01	3.21	3.41	3.60	3.80
KG127, KG160	E	59,5	64,5	69,5	74,5	79,5	84,5	89,5	94,5	99,5
	VE	2.34	2.54	2.74	2.93	3.23	3.33	3.52	3.72	3.92

M004, M004A, M004D, M004E

L1 = Free shaft length

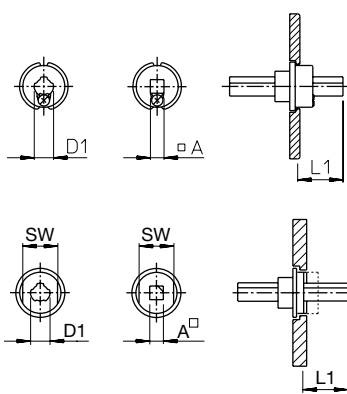

	Mounting	L1 ¹					D1	A	SW
		L1	L1	L1	L1	L1			
KG10A	E, VE	-	21-41	41-61	61-81	81-101	6	-	12
		-	.83-1.61	1.61-2.40	2.40-3.19	3.19-3.98	.24	-	.47
KG20A, KG32A	E	-	34,5-38	54,5-58	74,5-78	94,5-98	6	-	12
	VE	-	1.36-1.50	2.15-2.28	2.93-3.07	3.72-3.86	.24	-	.47
KG41B, KG64B	E	-	41,5-45	61,5-65	81,5-85	101,5-105	6	-	12
	VE	-	1.63-1.77	2.42-2.56	3.21-3.35	4.00-4.13	.24	-	.47
KG80, KG80C	E	29,5-35,5	43-49	63-69	83-89	103-109	8,5	6	16
	VE	1.16-1.40	1.69-1.93	2.48-2.72	3.27-3.50	4.06-4.29	.33	.24	.63
KG100, KG100C	E	32,5-38,5	46-52	66-72	86-92	106-112	8,5	6	16
	VE	1.28-1.52	1.81-2.05	2.60-2.83	3.39-3.62	4.17-4.41	.33	.24	.63
KG105, KG105C	E	25,5-31,5	39-45	59-65	79-85	99-105	8,5	6	16
	VE	1.00-1.24	1.54-1.77	2.32-2.56	3.11-3.35	3.90-4.13	.33	.24	.63
KG125, KG126	E	30,5-36,5	44-50	64-70	84-90	104-110	8,5	6	16
	VE	1.20-1.44	1.73-1.97	2.52-2.76	3.31-3.54	4.09-4.33	.33	.24	.63
KG127, KG160	E	39-53	69-83	99-113	129-143	159-173	11,2	8	22
	VE	1.54-2.09	2.72-3.27	3.90-4.45	5.08-5.63	6.26-6.81	.44	.32	.87
KG161, KG162	E	44-58	74-88	104-118	134-148	164-178	11,2	8	22
	VE	1.73-2.28	2.91-3.46	4.09-4.65	5.28-5.83	6.46-7.01	.44	.32	.87
KG210, KG211	E	38-52	68-82	98-112	128-142	158-172	11,2	8	22
	VE	1.50-2.03	2.68-3.23	3.86-4.41	5.04-5.59	6.22-6.77	.44	.32	.87
KG251, KG252	E	43-57	73-87	103-117	133-147	163-177	11,2	8	22
	VE	1.69-2.24	2.87-3.43	4.06-4.61	5.24-5.78	6.42-6.97	.44	.32	.87
KG315, KG316	E	43-57	73-87	103-117	133-147	163-177	11,2	8	22
	VE	1.69-2.24	2.87-3.43	4.06-4.61	5.24-5.78	6.42-6.97	.44	.32	.87
KG317									

¹Only for square shaft

Optional Extras

Simplified Door Clutches

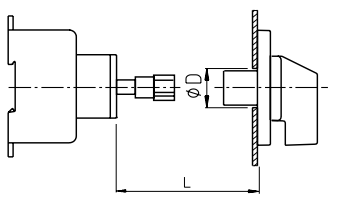

M290/A3, M290/A3.EF L = Standard length for switches of mounting VE

	L	L	L	L	L	D ¹
KG10A	37-57	57-77	77-97	97-117	-	18
	1.46-2.24	2.24-3.03	3.03-3.82	3.82-4.61	-	.71
KG20A, KG32A	55-68	75-88	95-108	115-128	-	18
	2.17-2.68	2.95-3.46	3.74-4.25	4.53-5.04	-	.71
KG41B, KG64B	60-70	80-90	100-110	120-130	-	18
	2.36-2.76	3.15-3.54	3.94-4.33	4.72-5.12	-	.71
KG80, KG100	56-68	76-88	96-108	116-128	-	18
KG105	2.20-2.68	2.99-3.46	3.78-4.25	4.57-5.04	-	.71

¹For KG10A, KG20A and KG32A with M290/A3.EF: 22/.87

M290/A1.EF L = Standard length for switches of mounting VE

	L	L	L	L	L	D
KG41B, KG64B	27-31	27-38	32-45	41-54	47-60	56-69
	1.06-1.22	1.06-1.50	1.26-1.77	1.61-2.13	1.85-2.36	1.97-2.72
KG80, KG100	27-32	27-40	33-47	42-55	48-62	57-70
KG105	1.06-1.26	1.06-1.57	1.30-1.85	1.65-2.17	1.89-2.44	2.24-2.76

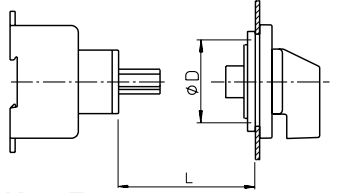

V840E

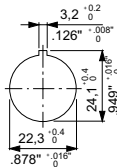
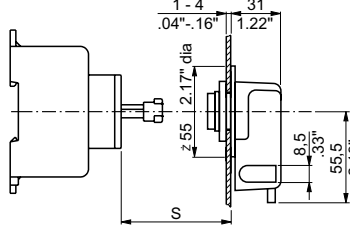

	S	
	min.	max.
KG10B	23	106
	.91	4.17
KG20B, KG32B	24,5	110
	.96	4.33
KG41B, KG64B	20	108
	.79	4.25
KG80, KG100	23	109
KG105	.91	4.29
KG125-KG317	21	110
	.83	4.33

V840G/V840F

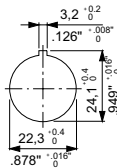
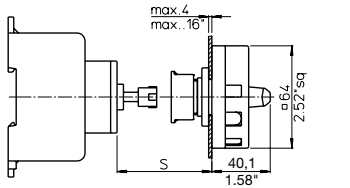

	S	
	min.	max.
KG10B	30	115
	1.02	4.49
KG20B, KG32B	27,5	113
	1.08	4.45
KG41B, KG64B	39,5	124
	1.56	4.88
KG80, KG100	27,5	122
KG105	1.08	4.80

V845

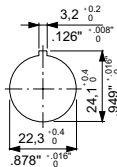
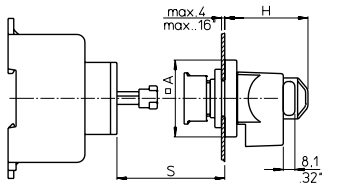

	S	
	min.	max.
KG10A	48	115
	1.89	4.53
KG10B	64	114
	2.52	4.49
KG20A, KG32A	48	119
	1.89	4.69
KG20B, KG32B	64	113
	2.52	4.45
KG41B, KG64B	64	124
	2.52	4.88
KG80, KG100	64	122
KG105	2.52	4.80

M600

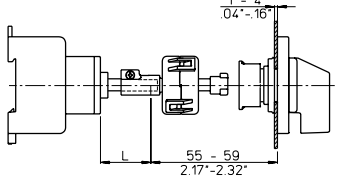

L see L100, M004D, M004, page 44.

Door Clutches

M700/.

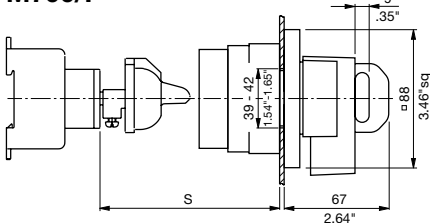

M701

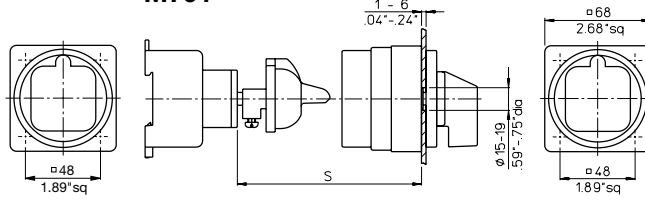

	S
KG10B	80
	3.15
KG20B, KG32B	61,5
	2.42
KG41B, KG64B	61,5
	2.42
KG80, KG100	61,5
KG105	2.42
KG125-KG317	61,5
	2.42

Optional Extras

Simplified Door Clutches

M810

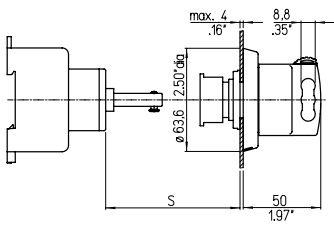

M800

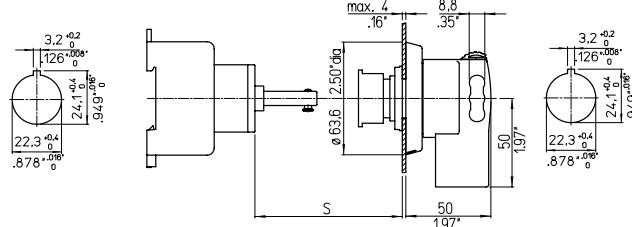

M810, M800

		S
KG41B, KG64B	3-pole	59
	6-pole	57
KG80, KG100 KG105	3-pole	56
	6-pole	53
KG125-KG317		56
		2.20

KG10A, KG20A, KG32A

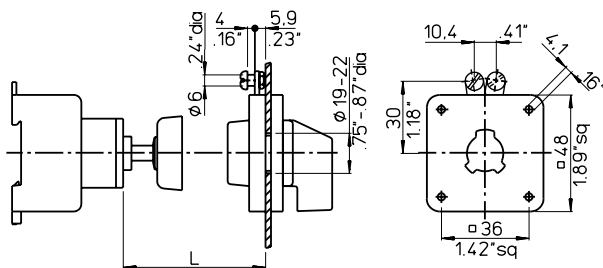

M280D, M280D/.EF, M280E, M280E/.EF

L = Standard length for switches of mounting VE

	L	L	L	L
KG10A	36-55	56-75	75-95	96-116
KG20A, KG32A	1.42-2.17	2.20-2.95	2.99-3.74	3.78-4.57
	58,5-66	78,5-86	98,5-106	118,5-126
	2.30-2.60	3.09-3.50	3.88-4.17	4.67-4.96

KG10B, KG20B, KG32B, KG41B, KG64B, KG80, KG100, KG105

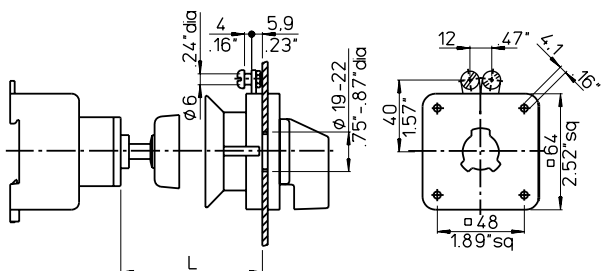

	L	L	L	L
KG10B	32-57	58-77	78-97	98-118
	1.26-2.24	2.28-3.03	3.07-3.82	3.86-4.65
KG20B, KG32B	57,5-65	77,5-85	97,5-105	117,5-125
	2.26-2.56	3.05-3.35	3.84-4.13	4.63-4.92
KG41B, KG64B	62-72	82-92	102-112	122-132
	2.44-2.83	3.23-3.62	4.02-4.41	4.80-5.20
KG80, KG100 KG105	60-70	80-90	100-110	120-130
	2.36-2.76	3.15-3.54	3.94-4.33	4.72-5.12

KG125-KG317

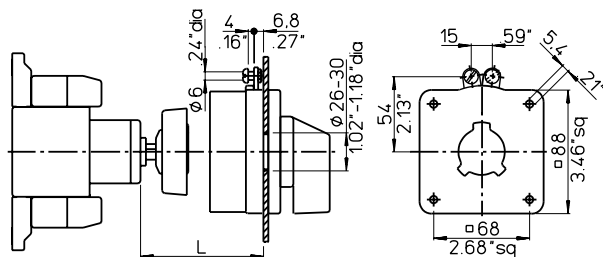

	L	L	L	L
KG125-KG317	93-109	123-139	153-169	183-199
	3.66-4.29	4.84-5.47	6.02-6.65	7.20-7.83

M280B/., M280B/.EF

L = Standard length for switches of mounting VE

	L	L	L	L
KG41, KG64	26-34	41-49	56-64	71-79
	1.02-1.34	1.61-1.93	2.20-2.52	2.80-3.11

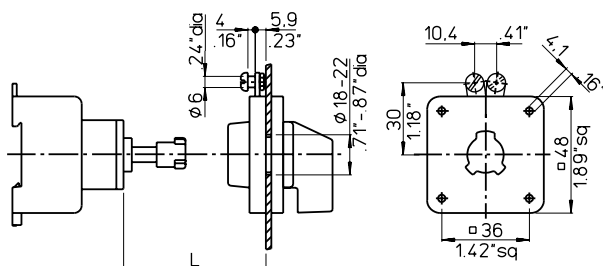

< back to table of contents >

Optional Extras

Padlock Devices, Additional Module for Motor Control Center (MCC), Angular drive

V840A

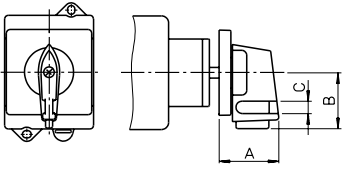

KG10A, KG20A, KG32A, KG41
KG64
KG10B, KG20B, KG32B, KG41B
KG64B, KG80, KG100, KG105

A	B	C
32,9	31,5	5
1.30	1.24	.20
41,6	40	7
1.64	1.57	.28

V840B

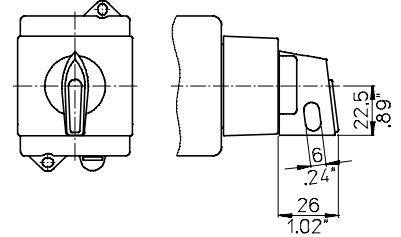

V845

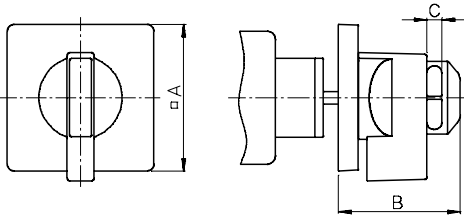

KG10A, KG20A, KG32A, KG41
KG64
KG10B, KG20B, KG32B, KG41B
KG64B, KG80, KG100, KG105
KG80C, KG100C, KG105C
KG125-KG317

A	B	C
48	51	7,2
1.89	2.01	.28
64	58	8,1
2.52	2.28	.32
88	73	9
3.47	2.87	.35

V840D

KG10A, KG20A, KG32A, KG41, KG64

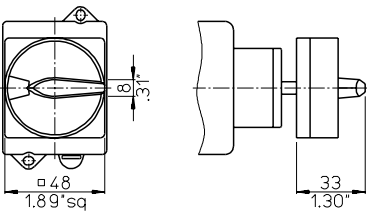

V840D

KG80C, KG100C, KG105C, KG125-KG162

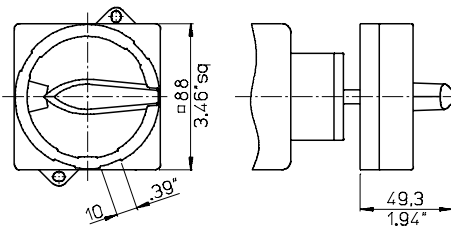

V840G/B, V840F/B

KG10B, KG20B, KG32B, KG41B, KG64B,
KG80, KG100, KG105

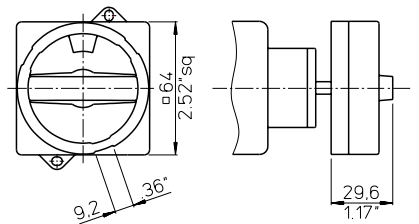

V840G, V840F/F

KG10B, KG20B, KG32B, KG41B, KG64B,
KG80, KG100, KG105

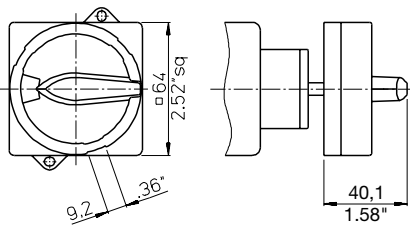

V840H/..E

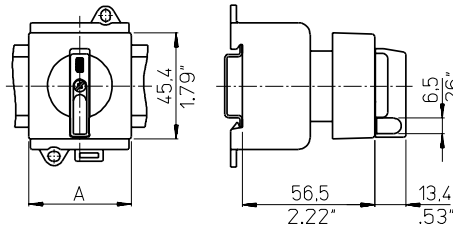

	A
KG20A, KG32A	43,7 1.72
KG41, KG64	52,4 2.06

V840VE

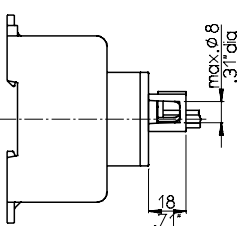

V500

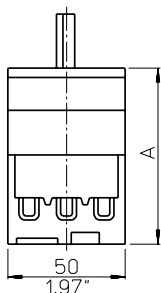

KG20B
KG32B
KG41B
KG64B

A
69,5
2.74
75
2.95

M330

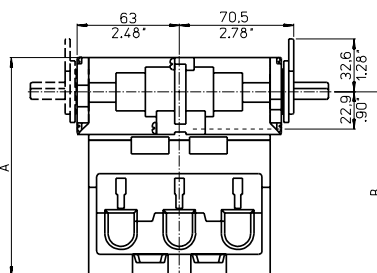

	A	B
KG125-	135	113,9
KG162	5.31	4.48
KG210-	142	120,9
KG317	5.59	4.76

Mounting

(Additional length for auxiliary contacts see page 50)

ON/OFF Switches 4 pole

E

	A	B	C	D1	D2 ¹	E	F	G	H	L
KH16-KHR25	48	36	4	10-15	5/3,5	30	12,2	60	56	49
	1.89	1.42	.16	.39-.59	.20/.14	1.18	.48	2.36	2.20	1.93
KH16B-KHR25B	64	48	4	10-15	5/3,5	30	12,2	60	56	49
	2.52	1.89	.16	.39-.59	.20/.14	1.18	.48	2.36	2.20	1.93
KH32, KHR32, KH40, KHR40	64	48	4	10-15	5/3,5	30	12,2	70	62	54
	2.52	1.89	.16	.39-.59	.20/.14	1.18	.48	2.76	2.44	2.13
KH63, KHR63 KH80, KHR80	64	48	4	10-15	5/4,5	37	14	86	90	62
	2.52	1.89	.16	.39-.59	.20/.18	1.46	.55	3.39	3.54	2.44

¹Dimensions after the slash are valid for two hole panel mounting

**FT2
FH3**

	A	G	H	L
KH16-KHR25 FT2	49	60	56	63,5
	1.93	2.36	2.20	2.50
KH16-KHR25 FH3	64	60	56	63,5
	2.52	2.36	2.20	2.50
KH32, KHR32, KH40, KHR40 FH3	64	70	62	68,7
	2.52	2.76	2.44	2.70
KH63, KHR63, KH80, KHR80 FH3	64	86	90	77,1
	2.52	3.39	3.54	3.04

VE

	A	B	C	D1	D2	D3	E	F	G	H	L
KH16-KHR25	48	36	12	8-15	5	4,2	60	22	60	56	47
	1.89	1.42	.47	.31-.59	.20	.17	2.36	.86	2.36	2.20	1.85
KH16B-KHR25B	64	48	13,5	10-15	5	4,2	60	22	60	56	47
	2.52	1.89	.53	.39-.59	.20	.17	2.36	.86	2.36	2.20	1.47
KH32, KHR32, KH40, KHR40	64	48	25,5	10-15	5	4,1	70	25	70	62	53,5
	2.52	1.89	1.00	.39-.59	.20	.16	2.76	.98	2.76	2.44	2.11
KH63, KHR63, KH80, KHR80	64	48	25,5	10-15	5	4,1	90	25	86	90	59,5
	2.52	1.89	1.00	.39-.59	.20	.16	3.54	.98	3.39	3.54	2.34

VE2

	A	B	G	L
KH16-KHR25	43,7	45,4	60	53,5
	1.72	1.79	2.36	2.11
KH32, KHR32	70,4	45,4	70	54,7
KH40, KHR40	2.77	1.79	2.76	2.15
KH63, KHR63	70,4	45,4	86	61,7
KH80, KHR80	2.77	1.79	3.39	2.43

[< back to table of contents >](#)

Mounting

(Additional length for auxiliary contacts see page 50)

ON/OFF Switches 8 pole and Double-throw Switches

E

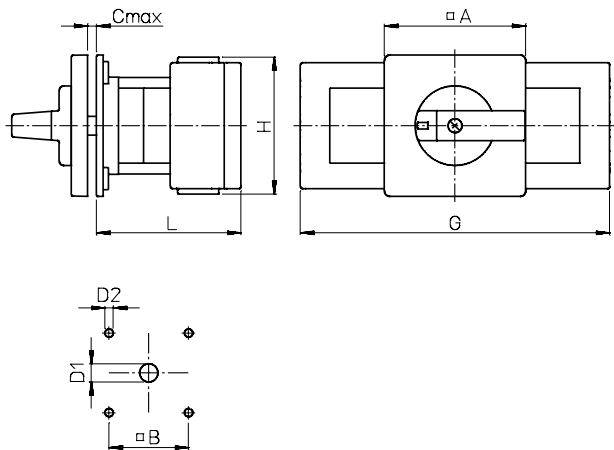

	A	B	C	D1	D2	G	H	L
KH16-KHR25	48	36	4	10-15	5	120,1	56	60
	1.89	1.42	.16	.39-.59	.20	4.73	2.20	2.36
KH16B-KHR25B	64	48	4	10-15	5	120,1	56	60
	2.52	1.89	.16	.39-.59	.20	4.73	2.20	2.36
KH32, KHR32	64	48	4	10-15	5	140,1	62	65,4
	2.52	1.89	.16	.39-.59	.20	5.52	2.44	2.57

[< back to table of contents >](#)

VE

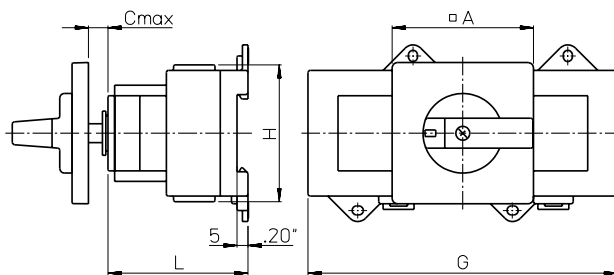

	A	C	G	H	L
KH16-KHR25	48	12	120,1	56	58
	1.89	.47	4.73	2.20	2.28
KH16B-KHR25B	64	13,5	120,1	56	58
	2.52	.53	4.73	2.20	2.28
KH32, KHR32	64	13,5	140,1	62	63,4
	2.52	.53	5.52	2.44	2.50

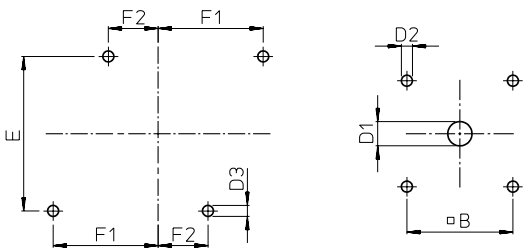

	B	D1	D2	D3	E	F1	F2
KH16-KHR25	36	10-15	5	4,2	60	41	19
	1.42	.39-.59	.20	.17	2.36	1.61	.75
KH16B-KHR25B	48	10-15	5	4,2	60	41	19
	1.89	.39-.59	.20	.17	2.36	1.61	.75
KH32, KHR32	48	10-15	5	4,1	70	47,5	22,5
	1.89	.39-.59	.20	.16	2.76	1.87	.89

VE2

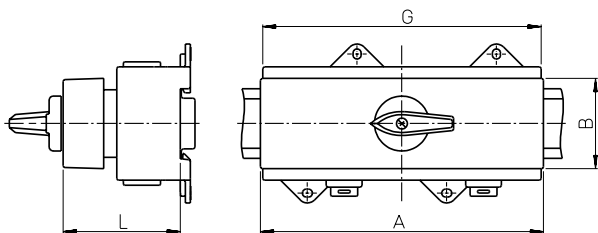

	A	B	G	L
KH32	142,4	45,4	140,1	60,9
KH40	5.61	1.79	5.52	2.40

Optional Extras

Protective Cover

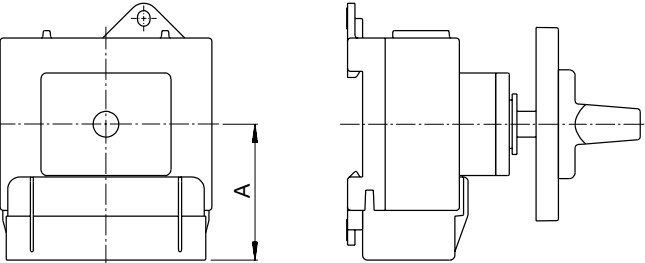

	A
KH32-KHR40	45 1.77
KH63-KHR80	68,5 2.70

Cam/rack-operated Auxiliary Contacts

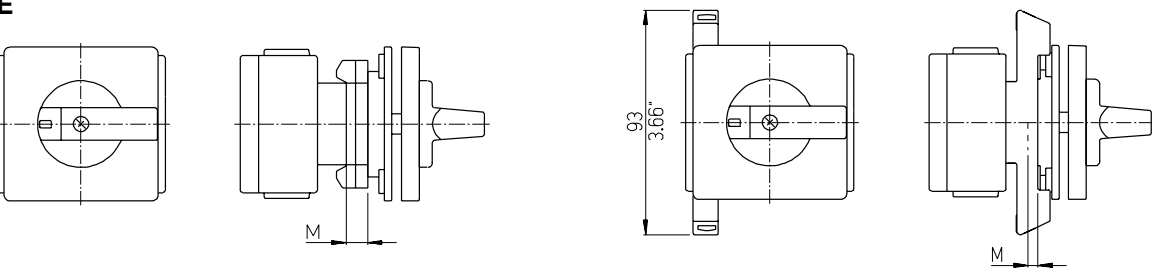

		M
KH16-KHR25B	1 or 2 contacts	9 .35
	3 or 4 contacts	25,8 1.02
KH32, KHR32, KH40, KHR40	1 or 2 contacts	0
	KH63, KHR63, KH80, KHR80	1 or 2 contacts

Lateral mounted Auxiliary Contacts

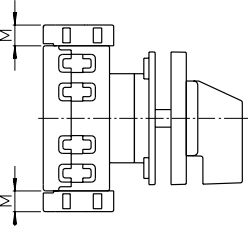

	M
KH16-KHR25B	10 .39
KH32, KHR32, KH40, KHR40	10 .39
KH63, KHR63, KH80, KHR80	10 .39

Ground Terminal

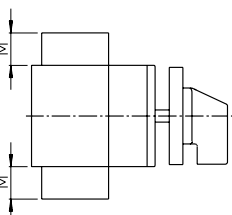

	M
KH16-KHR25B	13,5 .53
KH32, KHR32, KH40, KHR40	13,5 .53
KH63, KHR63, KH80, KHR80	20 .79

[< back to table of contents >](#)

Optional Extras

Switches in Plastic Enclosure

KL..., CL..., KS..., CS..

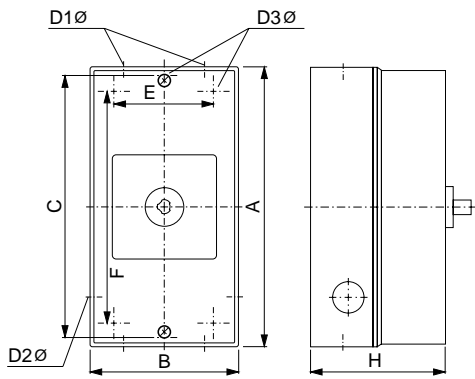

	A	B	C	D1	D2	D3	E	F	H
KH16 - KHR25	120	85	110	2x20/25 ¹	20	4,2	-	-	80
	4.72	3.35	4.33	2x.79/.98 ¹	.79	.17	-	-	3.15
KH16 - KHR25	160	85	150	2x20/25	20	4,2	-	-	80
	6.30	3.35	5.91	2x.79/.98	.79	.17	-	-	3.15
KH32 - KHR40	190	100	178	2x25	25	5,6	-	-	91
	7.48	3.94	7.01	2x.98	.98	.22	-	-	3.58
KH63 - KHR80	250	145	-	2x25/40	25	6,5	124	229	107
	9.84	5.71	-	2x.98/1.57	.98	.26	4.88	9.02	4.21
KH16B - KHR25B	250	145	-	2x25/40	25	6,5	124	229	107
	9.84	5.71	-	2x.98/1.57	.98	.26	4.88	9.02	4.21

¹CS... 2x20, 2 x .79

< back to table of contents >

L100, L100A

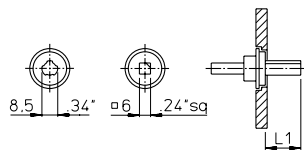

L1 = Free shaft length

	Mount- ing	L1	L1	L1	L1	L1	L1	L1	L1	L1	L1	L1	L1	L1	L1	L1	L1		
KH16B-KHR25B	E	11,5	16,5	20,5	24,5	29,5	34,5	39,5	44,5	49,5	54,5	59,5	64,5	69,5	74,5	79,5	84,5	89,5	94,5
		.45	.65	.81	.96	1.16	1.36	1.56	1.75	1.95	2.15	2.34	2.54	2.74	2.93	3.13	3.33	3.52	3.72
	VE	18	23	27	31	36	41	46	51	56	61	66	71	77	81	86	91	96	101
		.71	.91	1.06	1.22	1.42	1.61	1.81	2.01	2.20	2.40	2.60	2.80	3.03	3.19	3.39	3.58	3.78	3.98
KH32, KHR32, KH40, KHR40,	E	14,3	18,3	22,3	27,3	32,3	37,3	42,3	47,3	52,3	57,3	62,3	67,3	72,3	77,3	82,3	87,3	92,3	97,3
		.56	.72	.88	1.07	1.27	1.47	1.67	1.86	2.06	2.26	2.45	2.65	2.85	3.04	3.24	3.44	3.63	3.83
KH63, KHR63, KH80, KHR80	VE	19,8	23,8	27,8	32,8	37,8	42,8	47,8	52,8	57,8	62,8	67,8	72,8	77,8	82,8	87,8	92,8	97,8	102,8
		.78	.94	1.09	1.29	1.49	1.69	1.88	2.09	2.28	2.47	2.67	2.87	3.06	3.26	3.46	3.65	3.85	4.05

M004D, M004E

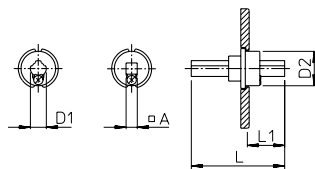

M004, M004A

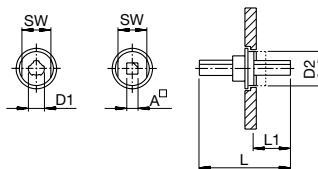

L = Shaft length
L1 = Free shaft length max.
¹ = Only for square shaft

	Mount- ing	L ¹	L1 ¹	L	L1	L	L1	L	L1	L	L1	D1	D2	A	SW
KH16-KHR25	E	-	-	60	11-38	80	31-58	100	51-78	120	71-98	6	13.8	-	12
				2.36	.43-1.50	3.15	1.22-2.28	3.94	2.01-3.07	4.72	2.80-3.86	.24	.54		.47
	VE	-	-	60	18-45	80	38-65	100	58-85	120	78-105	6	13.8	-	12
				2.36	.71-1.77	3.15	1.50-2.56	3.94	2.28-3.35	4.72	3.07-4.13	.24	.54		.47
KH32, KHR32, KH40, KHR40,	E	56,5	3-36	70	17-49	90	37-69	110	57-89	130	77-109	8,5	18,5	6	16
		2.22	.12-1.42	2.76	.67-1.93	3.54	1.46-2.72	4.33	2.24-3.50	5.12	3.03-4.29	.34	.73	.24	.63
KH63, KHR63, KH80, KHR80	VE	56,5	8-41	70	22-55	90	42-75	110	62-95	130	82-115	8,5	18,5	6	16
		2.22	.31-1.61	2.76	.87-2.17	3.54	1.65-2.95	4.33	2.44-3.74	5.12	3.23-4.53	.34	.73	.24	.63

Optional Extras

Simplified Door Clutches

M290/A3, M290/A3.EF

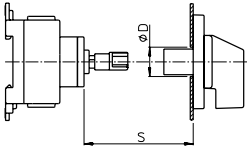

S = Standard length for switches of mounting VE

	S	S	S	S	D
KH16-KHR25	34,5-61,5 1.36-2.42	54,5-81,5 2.15-3.21	74,5-101,5 2.93-4.00	94,5-121,5 3.72-4.78	18 .71
KH32, KHR32, KH40, KHR40, KH63, KHR63, KH80, KHR80	28-55 1.10-2.17	55-75 2.17-2.95	75-95 2.95-3.74	95-115 3.74-4.53	18 .71

M290/A1.EF

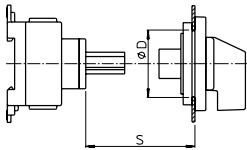

S = Standard length for switches of mounting VE

	S	S	S	S	S	S	D
KH32, KHR32, KH40, KHR40, KH63, KHR63, KH80, KHR80	25-30 .98-1.18	27-37 1.06-1.46	34-44 1.34-1.73	42-52 1.65-2.05	49-59 1.93-2.32	57-67 2.24-2.64	45,6 1.80

V840E

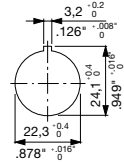
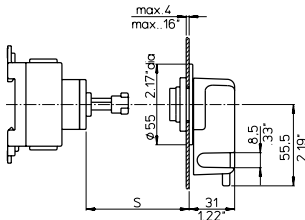

	S _{min.}	S _{max.}
KH16B-KHR25B	24,5 .96	110 4.33
KH32, KHR32, KH40, KHR40, KH63, KHR63, KH80, KHR80	20 .79	120 4.72

V840G/V840F

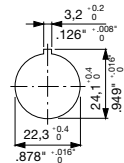
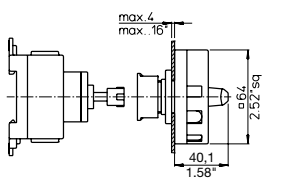

	S _{min.}	S _{max.}
KH16B-KHR25B	27,5 1.08	113 4.45
KH32, KHR32, KH40, KHR40, KH63, KHR63, KH80, KHR80	28 1.10	124 4.88

V845

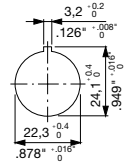
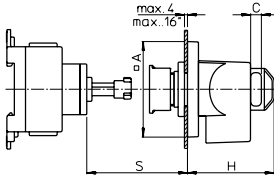

	A	C	H	S _{min.}	S _{max.}
KH16-KHR25	48 1.89	7,2 .28	52 2.05	29,5 1.16	119 4.69
KH16B-KHR25B	64 2.52	8,1 .32	58 2.28	27,5 1.08	113 4.45
KH32, KHR32, KH40, KHR40, KH63, KHR63, KH80, KHR80	64 2.52	8,1 .32	58 2.28	28 1.10	124 4.88

M600

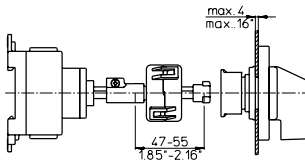

Door Clutches

M700/.

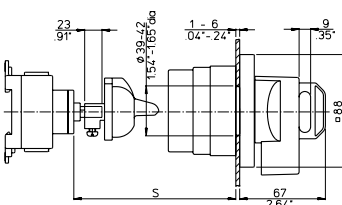

M701

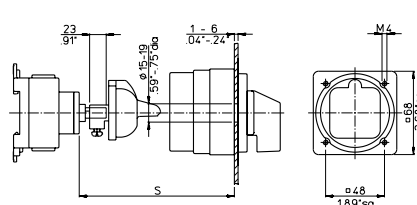

	S _{min.}	
	L100	M004D, M004
KH16B-KHR25B	61,5 2.42	-
KH32, KHR32, KH40, KHR40, KH63, KHR63, KH80, KHR80	61,5 2.42	68 2.68

Optional Extras

Door Clutches

M280D, M280D/.EF, M280E, M280E/.EF

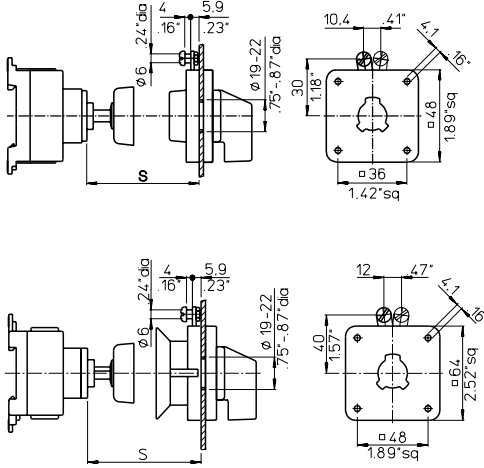

S = Standard length for switches of mounting VE

	S	S	S	S
KH16-KHR25	35-60	60-80	80-100	100-120
	1.38-2.36	2.36-3.15	3.15-3.94	3.94-4.72

	S	S	S	S
KH16B-KHR25B	37-64	64-84	84-104	104-124
	1.46-2.52	2.52-3.31	3.31-4.09	4.09-4.88
KH32, KHR32, KH40, KHR40, KH63, KHR63, KH80, KHR80	32-57	57-77	77-97	97-117
	1.26-2.24	2.24-3.03	3.03-3.82	3.82-4.61

< back to table of contents >

Padlock Devices

V840D

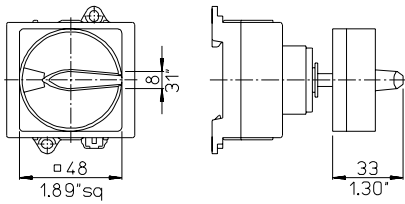

V840G, V840F/F

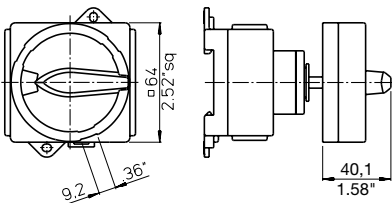

V840G/B, V840F/B

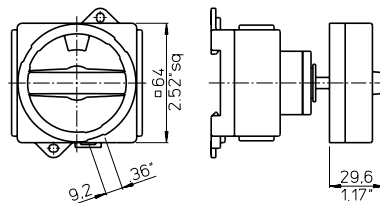

V840A

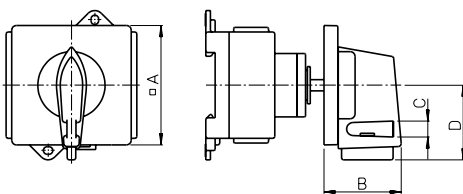

	A	B	C	D
KH16-KHR25	48	32,9	5	31,5
	1.89	1.30	.20	1.24
KH16B-KHR25B	64	41,6	7	40
	2.52	1.64	.28	1.57
KH32, KHR32, KH40, KHR40, KH63, KHR63, KH80, KHR80	64	41,6	7	40
	2.52	1.64	.28	1.57

V845

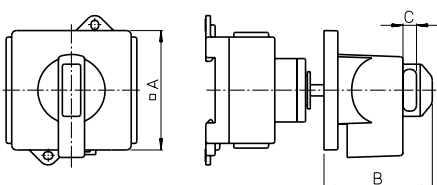

	A	B	C
KH16-KHR25	48	51	7,2
	1.89	2.01	.28
KH16B-KHR25B	64	58	8,1
	2.52	2.28	.32
KH32, KHR32, KH40, KHR40, KH63, KHR63, KH80, KHR80	64	58	8,1
	2.52	2.28	.32

The Range of “Blue Line” Switchgear

Technical literature covering the following products is available on request.

	Catalog Number
Main Switches and Main Switches with Emergency Function 16 A-315 A Maintenance Switches 20 A-315 A Switch Disconnectors 20 A-315 A According to IEC 60947-3, EN 60947-3, VDE 0660 part 107, IEC 60204, EN 60204 and VDE 0113	500
CL Switches 10 A-20 A C, CA and CAD Switches 10 A-315 A and L Switches 350 A-2400 A C, CA and CAD switches are designed for universal application. They are recommended for instrument, isolator, double-throw and motor control. L switches are designed for load and off-load applications. They are used to switch resistive or low inductive loads.	100
Optional Extras and Enclosures The complete product line, a large number of optional extras is available, including door interlocks, push-pull devices, cylinder and padlock attachments, control and indicator devices, AC motor drives, as well as enclosures, both insulated and metal.	101
A and AD Switches 6 A-25 A A and AD switches have 4 contacts in each switching stage. These switches provide an extensive range of switch functions and require a minimum mounting depth. Up to 36 switching positions are possible, with availability of 48 contacts per 12 stage switch column.	110
CG, CH and CHR Switches 10 A-25 A Ultra compact CG, CH and CHR switches are ideally suited for control and instrumentation applications. Switch terminals are “finger-proof” and conveniently accessible for wiring and are delivered open. All CG4 switches offer specially designed gold plated contacts or H-bridges with “cross-wire” contact systems, which facilitates their use in electronic circuitry and chemically aggressive environments.	120
DH, DHR, DK and DKR Switches 6 A-16 A DH, DHR, DK and DKR switches incorporate unique corrosion resistant contacts that permit operation on system voltage as low as 1 V. They have fully enclosed and protected contacts which can be operated either by rotary and/or lateral handle movement. D switches are used in calibration and semiconductor circuits. They are also used for relay and contactor control.	130
X Switches 80 A-630 A X switches can be applied for load, tap and gang switching duties. They incorporate 6 contacts in each switching stage. Their compact design provides a minimum length dimension for mounting purposes.	140
KG Switches 20 A-315 A and KH and KHR Switches 16 A-80 A KG, KH and KHR switches are excellent circuit interruptors. They have high through fault and fault making capacities and are especially designed for use as isolators and safety switches for machine tools, distribution panels and switchboards. KG ON/OFF switches offer unusually high dimensioned air and creepage distances between terminals which are designed for time saving “straight-line” wiring. ON/OFF switches are available with up to 8 poles and double-throw switches are available with up to 4 poles.	150
Push Buttons and Pilot Lights, 22,5 mm Ø A complete range of state-of-the-art push buttons and pilot lights represent an ideal combination of functional security and economical efficiency in a modular design.	302

We reserve the right to make technical and dimensional changes without prior notice.

Australia

Kraus & Naimer Pty. Ltd.
379 Liverpool Road, ASHFIELD, N.S.W. 2131
P: 1800 567 948
E: sales-au@krausnaimer.com

Austria

Kraus & Naimer GmbH
Schumannngasse 39
1180 WIEN
P: +43 1 404 06 0
E: sales-at@krausnaimer.com

Belgium, Luxembourg

Kraus & Naimer BV
Ikaros Business Park
Ikaroslaan 83
1930 ZAVENTHEM
P: +32 2 757 0141
F: +32 2 757 1640
E: sales-be@krausnaimer.com

Brazil

Central and South America
Kraus & Naimer Ind. Com. Ltda.
Rua Santa Monica, 1061
Parque Industrial San Jose
P: +55 11 2198 1288
F: +55 11 2198 1251
E: knbrasil@krausnaimer.com.br

Canada

Kraus & Naimer Ltd.
219 Connie Crescent, Unit 13A
CONCORD, Ontario, L4K 1L4
P: +1 905 738 1666
E: sales-ca@krausnaimer.com

Cyprus

ELECTROMATIC CONSTRUCTIONS LTD.
72, Evagoras Pallikarides Str., 2235 LATSIA-Nicosia
P. O. Box 12630, 2251 LATSIA-Nicosia
P: +357 2 48 41 41
F: +357 2 48 57 47
E: electromatic@cytanet.com.cy

Czech Republic

OBZOR, výrobní družstvo Zlín
Na Slanici 378
763 02 ZLÍN
P: +420 577 195 150
F: +420 577 195 152
E: odbyt@obzor.cz

Denmark

THIIM A/S
Transformervej 31
2860 SOEBORG
P: +45 4485 8000
F: +45 4485 8005
E: thiim@thiim.com

Finland

Kraus & Naimer Oy
Kiitoradankuja 8
01530 VANTAA
P: +358 9 825 424 0
E: sales-fi@krausnaimer.com

France

Kraus & Naimer s.a.s.
33, rue Bobillot
75013 PARIS
P: +33 1 58 40 80 80
E: sales-fr@krausnaimer.com

Germany

Kraus & Naimer GmbH
Wikingerstraße 20-28, 76189 KARLSRUHE
Postfach 10 01 24, 76231 KARLSRUHE
P: +49 721 59 88 0
E: sales-de@krausnaimer.com

Great Britain

Kraus & Naimer Ltd.
115 London Road
NEWBURY/BERKSHIRE RG14 2AH
P: +44 1635 262626
F: +44 1635 37807
E: sales-uk@krausnaimer.com

Greece

KALAMARAKIS-SAPOUNAS S. A.
Ionias & Neromilou Str., P. O. Box 46566
13671 ACHARNES/ATHENS
P: +30 2 10 240 6000 6
F: +30 2 10 240 6007
E: kalamarakis.sapounas@ksa.gr

Hungary

GANZ KK KFT.
X. Kőbányai út 41/c, Postfach 87
1475 BUDAPEST
P: +36 1 261 5479
E: ganzkk@ganzkk.hu

Iceland

JOHAN RÖNNING LTD.
Klettgarðar 25
104 REYKJAVIK
P: +354 5200 800
E: ronning@ronning.is

Republic of Ireland

Kraus & Naimer Ltd.
4235 Atlantic Avenue
Westpark Business Campus
Shannon, Co. Clare
P: +353 61 704700
F: +353 61 471084
E: sales-ie@krausnaimer.com

Italy

Kraus & Naimer s.r.l.
Via Terracini, 9
24047 TREVIGLIO (BG)
P: +39 0363 30 11 12
E: sales-it@krausnaimer.com

Japan

Kraus & Naimer Ltd.
Yoshiwada Building 2F
1-11-6 Hamamatsucho
Minato-Ku, TOKYO 105-0013
P: +81 3 3436 6151
F: +81 3 3436 6325
E: sales-jp@krausnaimer.com

Mexico

JC INGENIERÍA Y CONTROL, SA DE CV.
Ángel Gaviño 30,
C. Satélite, C. Medicos,
Naucalpan Edo. de Mexico, C.P. 53100
P: +52 55 55 62 75 77
F: +52 55 55 62 04 34
E: ventas@jcingenieriacontrol.com

Netherlands

Kraus & Naimer B.V.
Wegtersweg 38-40, Postbus 199
7556 BR HENGEL0 (Ov.)
P: +31 74 291 9441
F: +31 74 291 98380
E: sales-nl@krausnaimer.com

New Zealand

Kraus & Naimer Ltd.
42 Miramar Avenue, WELLINGTON 6022
P. O. Box 15-009, WELLINGTON 6243
P: + 64 0800 736 522
E: sales-nz@krausnaimer.com

Norway

Kraus & Naimer AB Avd. Norge
Postboks 27 Vollebakk
0516 Oslo
P: +47 22 64 44 20
E: sales-no@krausnaimer.com

Poland

ASTAT LOGISTYKA SP. Z O.O.
Dąbrowskiego 441
60451 POZNAŃ
P: +48 61 849 80 89
E: k.swiderski@astat.pl

Portugal

ELECTRICAL-DAMAS, FERREIRA & DAMASCENO, LDA.
Apartado 1063, S. Ant. Cavaleiros
2670 LOURES
P: +351 21 989 8939
F: +351 21 988 6464
E: electrical@electrical.pt

Singapore, India, Middle East – UAE

Kraus & Naimer Pte. Ltd.
115A, Commonwealth Drive
#03-17/23
SINGAPORE 149 596
P: +65 6473 8166
E: sales-sg@krausnaimer.com

Slovenia

SCHRACK TECHNIK D.O.O.
Pameče 175
SI-2380 SLOVENJ GRADEC
P: +386 2 88 392 00
F: +386 2 88 434 71
E: d.goljat@schrack.si

Republic of South Africa

Kraus & Naimer Pty. Ltd.
7 Village Crescent, Linbro Village
Linbro Business Park, SANDTON 2065
P. O. Box 511, KELVIN 2054
P: +27 11 608 6060
E: sales-za@krausnaimer.com

Spain

Kraus & Naimer B.V.
P: +34 662 696 014
E: sales-es@krausnaimer.com

Sweden

Kraus & Naimer AB
Dr. Widerströms Gata 11, Hägersten
Box 42097, 126 14 STOCKHOLM
P: +46 8 97 00 80
E: sales-se@krausnaimer.com

Switzerland

AWAG Elektrotechnik AG
Sandbühlstraße 2
CH-8604 VOLKETSCHWIL
P: +41 44 908 19 19
E: info@awag.ch

Turkey

KARDES ELEKTRİK SANAYİ VE TİCARET A.Ş.
Yassıoren Mah. Hıfıa Sok. No: 4
34277 Arnavutköy-Istanbul-Turkey
P: +90 212 624 92 04 118
F: +90 212 592 48 10
E: info@unalkardes.com.tr

USA

Kraus & Naimer Inc.
760 New Brunswick Road
SOMERSET, NJ 08873
P: +1 732 560 1240
E: sales-us@krausnaimer.com



Kraus & Naimer



Contact us:

www.krausnaimer.com